

Noble Prize Chemistry , Noble Prize Physics and Noble Prize Physiology (2018) Are On Incomplete Theory Work . Unless Divine Mechanics (CCP , Code PcPs and CP) Or ToE , That Underpins All Sciences , Is Explained First , Work Should Not Be Honored .(Marks Allotted 3 out of 10 to Each Noble Prize)

V M Das

Advanced Sciences ,University Of God
Das nursing Home , Fatehgarh, Farrukhabad , U.P. , India
Corresponding Author: V M Das

Abstract: Mind , the inner most box of nature has not been investigated by modern physicists . Mind has not been incorporated in Standard model. Mind can only be studied by participatory science. Having searched Basic building blocks of the universe i.e. mass part of reality (figure 1) , we have also investigated mind part of reality and finally two fundamental particles with mind and mass realities are hypothesized . Now we discuss how to further investigate mind so as to know their structures and functions. Atomic genetics is the branch of science where we investigate about fundamental interactions of the universe i.e. atomic transcription and translations . New words have been coined to understand hidden science of mind part of reality. Mind reality have been recognized as different faces by “I” about 5000 years back to Arjuna in Mahabharata. It is just like to understand any language through Alphabets. These are (different faces) Alphabets of mind reality. One Mind reality has one face identity and the second mind reality has second face identity and so on. The facial expression represents phenomenon of intelligence and different face represents different types of properties carrying property. The open eyes means property is activated while close eye means property is inactivated. In spite of carrying properties conscious ness they also know how to conduct not only origin of universe but also how to create two different universe i.e. next creation could be different from this creation . In all, It is automatic system of the universe . The mind realities which are of good properties have devtas face identity (first five faces on both side) and those mind realities which are of bad properties have demons face identity (last four faces on both side) . These are named as code PCPs or messenger atomic genes . The central face is CCP or Thought script where all thoughts of the universe are banked . It is bank of data of all information s of the universe It is face identity of Anti mind particles as data of all information’s of the universe are stored as anti mind particles . It is the Time mind ness (biological clock) that keeps on expressing different thoughts from this thought script (CCP) . There are four more faces (black bodies) shown on extreme left and right floating in fire are CPs (translating Atomic genes) . That translates the messages and realizes it and reacts accordingly . Rest pictures are creation of different individuals and nature (sun , moon and snake and other pictures made on hands and body) by different thoughts of Almighty B.B.B. The entire picture has been explained in Geeta in 11/ 10 and 11 .Whatever is being created in this universe is basically not by our thoughts rather it is the thought of Almighty B.B.B (Yang B.B.B or matter B.B.B. or Male B.B.B working as Highest center of the universe.) that is dominated over creation and destruction of this cycle of the universe. (figure 9.1)

Keywords: Basic Building Blocks, Atomic Genetics, Atomic Transcription and Translation, Tachyons, Atomic Genetic Engineering , Hoyle -Narlikar universe ,

Date of Submission: 01-10-2018

Date of acceptance: 16-10-2018

I. Introduction

The Royal Swedish Academy of Sciences has decided to award the Nobel Prize in Chemistry 2018 with one half to **Frances H. Arnold**, California Institute of Technology, Pasadena, USA “*for the directed evolution of enzymes*” and the other half jointly to **George P. Smith**, University of Missouri, Columbia, USA and **Sir Gregory P. Winter**, MRC Laboratory of Molecular Biology, Cambridge, UK “*for the phage display of peptides and antibodies*”.

They harnessed the power of evolution

The power of evolution is revealed through the diversity of life. The 2018 Nobel Laureates in Chemistry have taken control of evolution and used it for purposes that bring the greatest benefit to humankind. Enzymes produced through directed evolution are used to manufacture everything from biofuels to pharmaceuticals. Antibodies evolved using a method called phage display can combat autoimmune diseases and in some cases cure metastatic cancer.

Since the first seeds of life arose around 3.7 billion years ago, almost every crevice on Earth has filled with different organisms. Life has spread to hot springs, deep oceans and dry deserts, all because evolution has solved a number of chemical problems. Life's chemical tools – proteins – have been optimised, changed and renewed, creating incredible diversity. This year's Nobel Laureates in Chemistry have been inspired by the power of evolution and used the same principles – genetic change and selection – to develop proteins that solve mankind's chemical problems.

One half of this year's Nobel Prize in Chemistry is awarded to **Frances H. Arnold**. In 1993, she conducted the first directed evolution of enzymes, which are proteins that catalyse chemical reactions. Since then, she has refined the methods that are now routinely used to develop new catalysts. The uses of Frances Arnold's enzymes include more environmentally friendly manufacturing of chemical substances, such as pharmaceuticals, and the production of renewable fuels for a greener transport sector. The other half of this year's Nobel Prize in Chemistry is shared by **George P. Smith** and **Sir Gregory P. Winter**. In 1985, George Smith developed an elegant method known as phage display, where a bacteriophage – a virus that infects bacteria – can be used to evolve new proteins. Gregory Winter used phage display for the directed evolution of antibodies, with the aim of producing new pharmaceuticals. The first one based on this method, adalimumab, was approved in 2002 and is used for rheumatoid arthritis, psoriasis and inflammatory bowel diseases. Since then, phage display has produced anti-bodies that can neutralise toxins, counteract autoimmune diseases and cure metastatic cancer.

We are in the early days of directed evolution's revolution which, in many different ways, is bringing and will bring the greatest benefit to humankind.

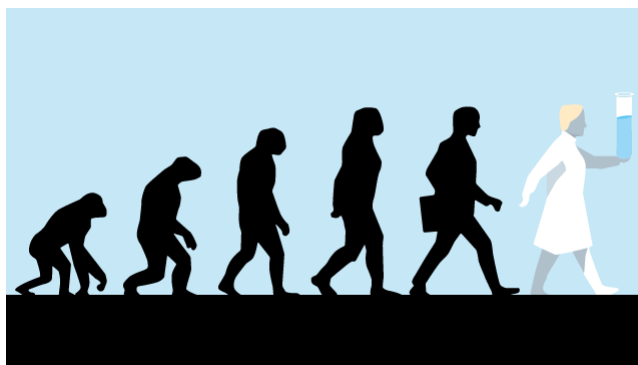

The Nobel Prize in Physics 2018

2 October 2018

The Royal Swedish Academy of Sciences has decided to award the Nobel Prize in Physics 2018 with one half to **Arthur Ashkin**, Bell Laboratories, Holmdel, USA and the other half jointly to **G rard Mourou**,  cole Polytechnique, Palaiseau, France and University of Michigan, Ann Arbor, USA and **Donna Strickland**, University of Waterloo, Canada.

The Royal Swedish Academy of Sciences has decided to award the Nobel Prize in Physics 2018 *“for groundbreaking inventions in the field of laser physics”* with one half to **Arthur Ashkin**, Bell Laboratories, Holmdel, USA *“for the optical tweezers and their application to biological systems”* and the other half jointly to **G rard Mourou**,  cole Polytechnique, Palaiseau, France and University of Michigan, Ann Arbor, USA and **Donna Strickland**, University of Waterloo, Canada *“for their method of generating high-intensity, ultra-short optical pulses”*. Listen to interview with Donna Strickland from the press conference (mp3)

Tools made of light The inventions being honoured this year have revolutionised laser physics. Extremely small objects and incredibly rapid processes are now being seen in a new light. Advanced precision instruments are opening up unexplored areas of research and a multitude of industrial and medical applications.

Arthur Ashkin invented optical tweezers that grab particles, atoms, viruses and other living cells with their laser beam fingers. This new tool allowed Ashkin to realise an old dream of science fiction – using the radiation pressure of light to move physical objects. He succeeded in getting laser light to push small particles towards the centre of the beam and to hold them there. Optical tweezers had been invented. A major breakthrough came in 1987, when Ashkin used the tweezers to capture living bacteria without harming them. He

immediately began studying biological systems and optical tweezers are now widely used to investigate the machinery of life.

Gérard Mourou and **Donna Strickland** paved the way towards the shortest and most intense laser pulses ever created by mankind. Their revolutionary article was published in 1985 and was the foundation of Strickland's doctoral thesis. Using an ingenious approach, they succeeded in creating ultrashort high-intensity laser pulses without destroying the amplifying material. First they stretched the laser pulses in time to reduce their peak power, then amplified them, and finally compressed them. If a pulse is compressed in time and becomes shorter, then more light is packed together in the same tiny space – the intensity of the pulse increases dramatically.

Strickland and Mourou's newly invented technique, called *chirped pulse amplification*, CPA, soon became standard for subsequent high-intensity lasers. Its uses include the millions of corrective eye surgeries that are conducted every year using the sharpest of laser beams. The innumerable areas of application have not yet been completely explored. However, even now these celebrated inventions allow us to rummage around in the microworld in the best spirit of Alfred Nobel – for the greatest benefit to humankind.

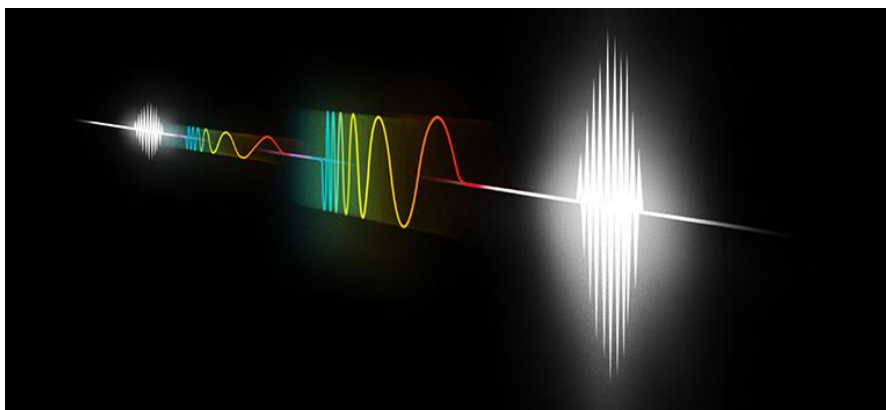

The 2018 Nobel Prize in Physiology or Medicine jointly to James P. Allison and Tasuku Honjo “**for their discovery of cancer therapy by inhibition of negative immune regulation**”

II. Summary

Cancer kills millions of people every year and is one of humanity's greatest health challenges. By stimulating the inherent ability of our immune system to attack tumor cells this year's Nobel Laureates have established an entirely new principle for cancer therapy. James P. Allison studied a known protein that functions as a brake on the immune system. He realized the potential of releasing the brake and thereby unleashing our immune cells to attack tumors. He then developed this concept into a brand new approach for treating patients. In parallel, Tasuku Honjo discovered a protein on immune cells and, after careful exploration of its function, eventually revealed that it also operates as a brake, but with a different mechanism of action. Therapies based on his discovery proved to be strikingly effective in the fight against cancer. Allison and Honjo showed how different strategies for inhibiting the brakes on the immune system can be used in the treatment of cancer. The seminal discoveries by the two Laureates constitute a landmark in our fight against cancer.

Can our immune defense be engaged for cancer treatment?

Cancer comprises many different diseases, all characterized by uncontrolled proliferation of abnormal cells with capacity for spread to healthy organs and tissues. A number of therapeutic approaches are available for cancer treatment, including surgery, radiation, and other strategies, some of which have been awarded previous Nobel Prizes. These include methods for hormone treatment for prostate cancer (Huggins, 1966), chemotherapy (Elion and Hitchins, 1988), and bone marrow transplantation for leukemia (Thomas 1990). However, advanced cancer remains immensely difficult to treat, and novel therapeutic strategies are desperately needed.

In the late 19th century and beginning of the 20th century the concept emerged that activation of the immune system might be a strategy for attacking tumor cells. Attempts were made to infect patients with bacteria to activate the defense. These efforts only had modest effects, but a variant of this strategy is used today in the treatment of bladder cancer. It was realized that more knowledge was needed. Many scientists engaged in intense basic research and uncovered fundamental mechanisms regulating immunity and also showed how the immune system can recognize cancer cells. Despite remarkable scientific progress, attempts to develop generalizable new strategies against cancer proved difficult.

Accelerators and brakes in our immune system

The fundamental property of our immune system is the ability to discriminate “self” from “non-self” so that invading bacteria, viruses and other dangers can be attacked and eliminated. T cells, a type of white blood cell, are key players in this defense. T cells were shown to have receptors that bind to structures recognized as non-self and such interactions trigger the immune system to engage in defense. But additional proteins acting as T-cell accelerators are also required to trigger a full-blown immune response (see Figure). Many scientists contributed to this important basic research and identified other proteins that function as brakes on the T cells, inhibiting immune activation. This intricate balance between accelerators and brakes is essential for tight control. It ensures that the immune system is sufficiently engaged in attack against foreign microorganisms while avoiding the excessive activation that can lead to autoimmune destruction of healthy cells and tissues.

A new principle for immune therapy

During the 1990s, in his laboratory at the University of California, Berkeley, James P. Allison studied the T-cell protein CTLA-4. He was one of several scientists who had made the observation that CTLA-4 functions as a brake on T cells. Other research teams exploited the mechanism as a target in the treatment of autoimmune disease. Allison, however, had an entirely different idea. He had already developed an antibody that could bind to CTLA-4 and block its function (see Figure). He now set out to investigate if CTLA-4 blockade could disengage the T-cell brake and unleash the immune system to attack cancer cells. Allison and co-workers performed a first experiment at the end of 1994, and in their excitement it was immediately repeated over the Christmas break. The results were spectacular. Mice with cancer had been cured by treatment with the antibodies that inhibit the brake and unlock antitumor T-cell activity. Despite little interest from the pharmaceutical industry, Allison continued his intense efforts to develop the strategy into a therapy for humans. Promising results soon emerged from several groups, and in 2010 an important clinical study showed striking effects in patients with advanced melanoma, a type of skin cancer. In several patients signs of remaining cancer disappeared. Such remarkable results had never been seen before in this patient group.

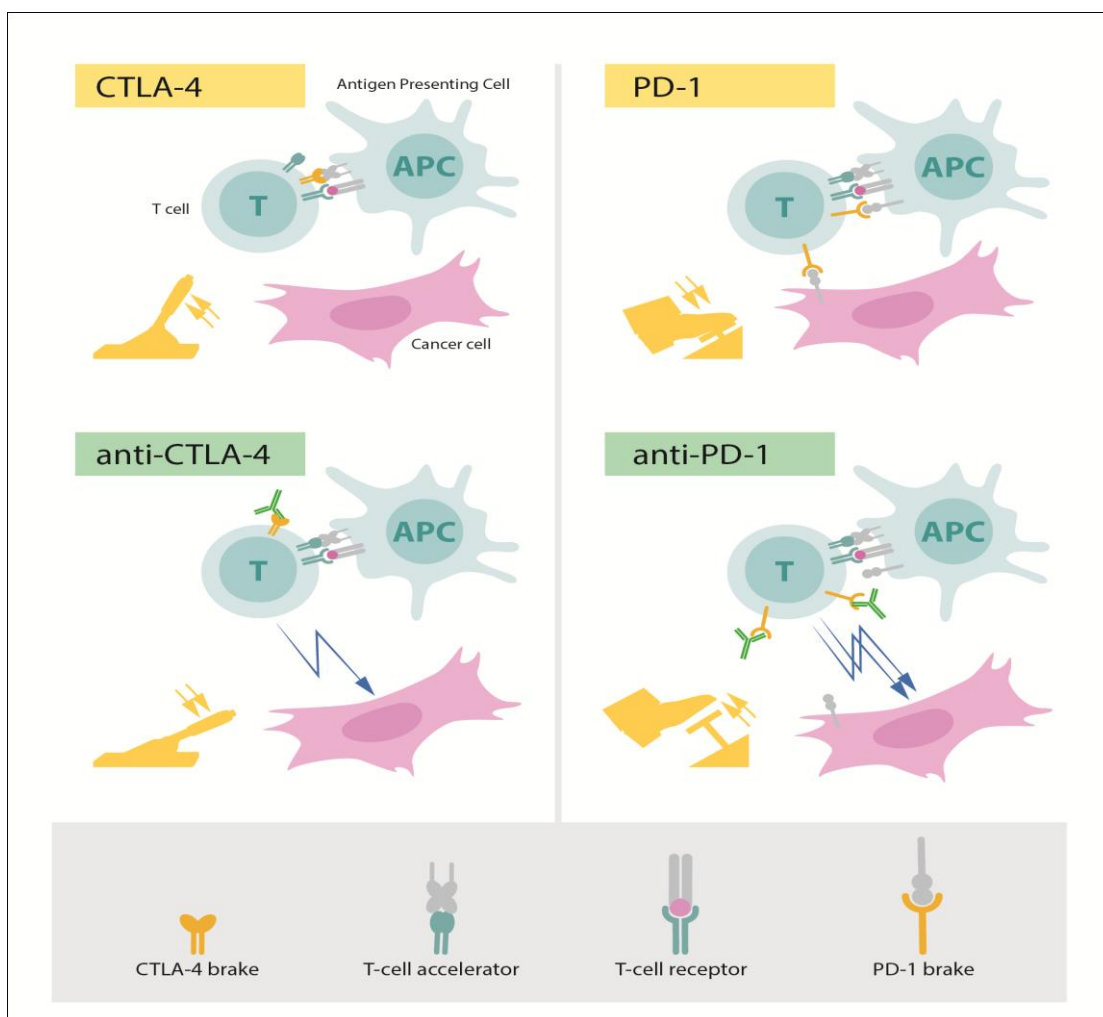

Figure: Upper left: Activation of T cells requires that the T-cell receptor binds to structures on other immune cells recognized as "non-self". A protein functioning as a T-cell accelerator is also required for T cell activation. CTLA- 4 functions as a brake on T cells that inhibits the function of the accelerator.**Lower left:** Antibodies (green) against CTLA-4 block the function of the brake leading to activation of T cells and attack on cancer cells.**Upper right:** PD-1 is another T-cell brake that inhibits T-cell activation. **Lower right:** Antibodies against PD-1 inhibit the function of the brake leading to activation of T cells and highly efficient attack on cancer cells.

Discovery of PD-1 and its importance for cancer therapy

In 1992, a few years before Allison’s discovery, Tasuku Honjo discovered PD-1, another protein expressed on the surface of T-cells. Determined to unravel its role, he meticulously explored its function in a series of elegant experiments performed over many years in his laboratory at Kyoto University. The results showed that PD-1, similar to CTLA-4, functions as a T-cell brake, but operates by a different mechanism (see Figure). In animal experiments, PD-1 blockade was also shown to be a promising strategy in the fight against cancer, as demonstrated by Honjo and other groups. This paved the way for utilizing PD-1 as a target in the treatment of patients. Clinical development ensued, and in 2012 a key study demonstrated clear efficacy in the treatment of patients with different types of cancer. Results were dramatic, leading to long-term remission and possible cure in several patients with metastatic cancer, a condition that had previously been considered essentially untreatable.

Immune checkpoint therapy for cancer today and in the future

After the initial studies showing the effects of CTLA-4 and PD-1 blockade, the clinical development has been dramatic. We now know that the treatment, often referred to as “immune checkpoint therapy”, has fundamentally changed the outcome for certain groups of patients with advanced cancer. Similar to other cancer therapies, adverse side effects are seen, which can be serious and even life threatening. They are caused by an overactive immune response leading to autoimmune reactions, but are usually manageable. Intense continuing research is focused on elucidating mechanisms of action, with the aim of improving therapies and reducing side effects. Of the two treatment strategies, checkpoint therapy against PD-1 has proven more effective and positive results are being observed in several types of cancer, including lung cancer, renal cancer, lymphoma and melanoma. New clinical studies indicate that combination therapy, targeting both CTLA-4 and PD-1, can be even more effective, as demonstrated in patients with melanoma. Thus, Allison and Honjo have inspired efforts to combine different strategies to release the brakes on the immune system with the aim of eliminating tumor cells even more efficiently. A large number of checkpoint therapy trials are currently underway against most types of cancer, and new checkpoint proteins are being tested as targets. For more than 100 years scientists attempted to engage the immune system in the fight against cancer. Until the seminal discoveries by the two laureates, progress into clinical development was modest. Checkpoint therapy has now revolutionized cancer treatment and has fundamentally changed the way we view how cancer can be managed.

Hoyle Narlikar Universe - OR -- Universe “I”

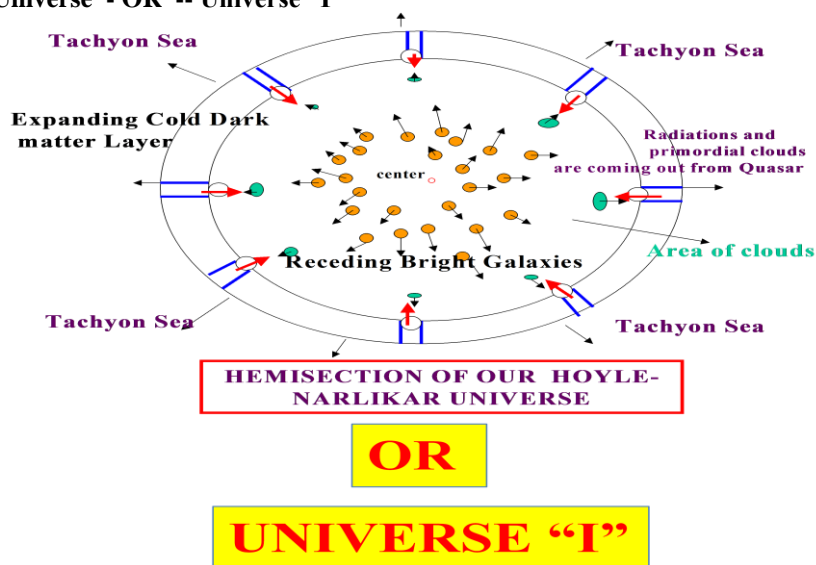

What is New Physics or Physics of Mind ?

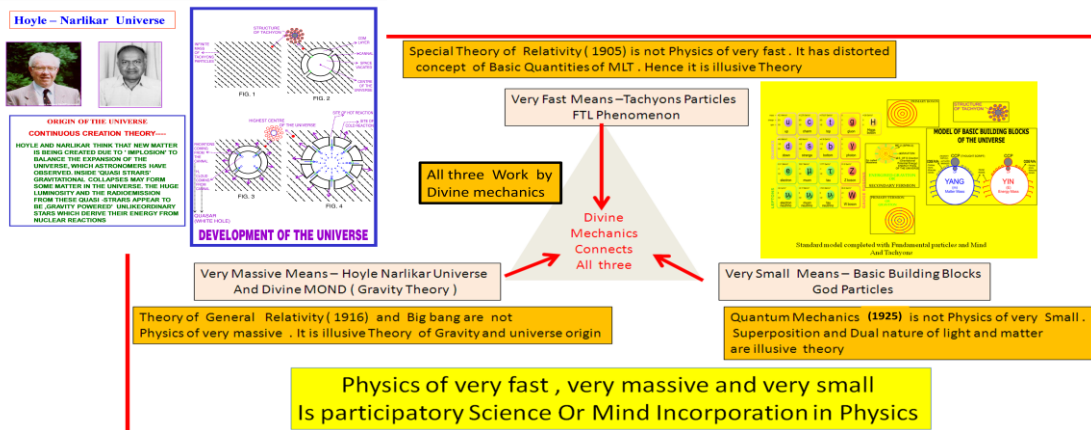

Physics of Mind

Quantum Consciousness – According to Physicists and Biologist



The nature of consciousness remains deeply mysterious and profoundly important, with existential, medical and spiritual implication. We know what it is like to *be* conscious – to have awareness, a conscious ‘mind’, but who, or what, are ‘we’ who know such things? How is the subjective nature of phenomenal experience – our ‘inner life’ - to be explained in scientific terms? What consciousness actually *is*, and how it comes about remain unknown. The general assumption in modern science and philosophy - the ‘standard model’ - is that consciousness emerges from complex computation among brain neurons, computation whose currency is seen as neuronal firings (‘spikes’) and synaptic transmissions, equated with binary ‘bits’ in digital computing. Consciousness is presumed to ‘emerge’ from complex neuronal computation, and to have arisen during biological evolution as an adaptation of living systems, extrinsic to the makeup of the universe. On the other hand, spiritual and contemplative traditions, and some scientists and philosophers consider consciousness to be intrinsic, ‘woven into the fabric of the universe’. In these views, conscious precursors and Platonic forms preceded biology, existing all along in the fine scale structure of reality.

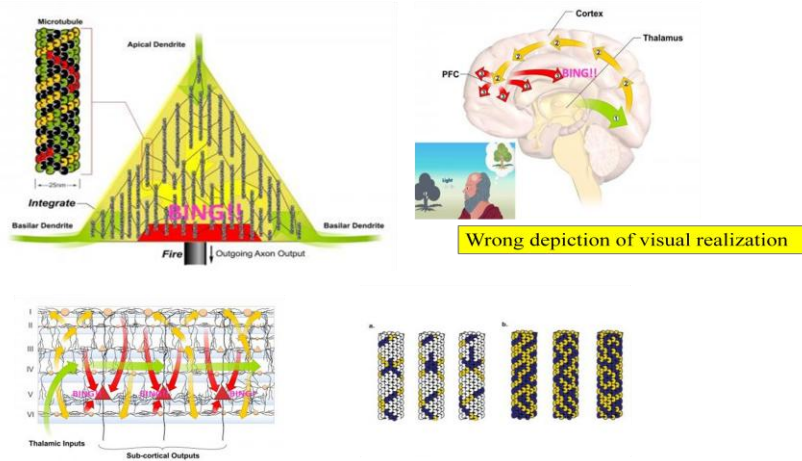

My research involves a theory of consciousness which can bridge these two approaches, a theory developed over the past 20 years with eminent British physicist Sir Roger Penrose. Called ‘orchestrated objective reduction’ (‘Orch OR’), it suggests consciousness arises from quantum vibrations in protein polymers called microtubules inside the brain’s neurons, vibrations which interfere, ‘collapse’ and resonate across scale, control neuronal firings, generate consciousness, and connect ultimately to ‘deeper order’ ripples in spacetime geometry. Consciousness is more like music than computation.

Colleagues Travis Craddock and Jack Tuszynski and I also study how anesthetics act in microtubules to erase consciousness, and with Jay Sanguinetti, John JB Allen and Sterling Cooley, we are studying how transcranial ultrasound (TUS) can be used noninvasively to resonate brain microtubules and treat mental, cognitive and neurological disorders. Many thanks to my assistant Abi Behar-Montefiore and Ed Xia for maintaining this website.

1.2 Mind and Mass Realities [2]

This is called **Final Truth** . **Mind and Mass** mysteries have emerged like
OMNIPRESENT . I.e. Every small and bigger units are made up of these **B.B.Bs**
I am The origin of all every thing evolved from Me.—Gita 10/8
 These are divine in the sense that they talk with each other. They have power to transmutate to form any bigger unit of the universe . The triggering activity is atomic transcription and translation.

MODEL OF BASIC BUILDING BLOCKS OF THE UNIVERSE

YANG (M) Matter Mass
YIN (E) Energy Mass

CP is shown in the Picture (Realisation Particle)

UNITY OF OPPOSITE
BOTH ARE COMPLEMENTARY
DIVINE B.B.B.s
MIND & MASS REALITY

(ATOMIC GENESIS) (MATTER-MASS ENERGY MASS)

Mind & Mass : Part of Truth

CCP of YANG
 Code PCPs
 CCP of YIN
 CPs
 Divine Hooks
 Matter Mass
 Energy Mass

GOD PARTICLES
“I” First God Of symmetry phase

Fig. 1 Divine Mechanics Unit – CCP, CP and information s – Code PcPs with B-Bit – Mass

Atomic genetics is the branch of science where we investigate about fundamental interactions of the universe i.e. atomic transcription and translations . New words have been coined to understand hidden science of mind part of reality. Mind reality has been recognized as different faces by “I” about 5000 years back to Arjuna in Mahabharata.as shown in Fig 1. It is just like to understand any language through Alphabets. These are (different faces) Alphabets of mind reality. One Mind reality has one face identity and the second mind reality has second face identity and so on. The facial expression represents phenomenon of intelligence and

different faces represent different types of properties carrying property. The open eyes means property is activated while close eye means property is inactivated. In spite of carrying properties consciousness they also know how to conduct not only origin of universe but also how to create two different universe i.e. next creation could be different from this creation . In all, it is automatic system of the universe . The mind realities which are of good properties have devtas face identity (first five faces on both side) and those mind realities which are of bad properties have demons face identity (last four faces on both side) . These are named as code PCPs or messenger atomic genes . The central face is CCP or Thought script where all thoughts of the universe are banked . It is bank of data of all information s of the universe It is face identity of Anti mind particles as data of all information's of the universe are stored as anti mind particles . It is the Time mind ness (biological clock) that keeps on expressing different thoughts from this thought script (CCP) . There are four more faces (black bodies) shown on extreme left and right floating in fire are CPs (translating Atomic genes) . That translates the messages and realizes it and reacts accordingly.[2]

1.3. Messages From Biological world to understand B.B.B world as shown in Fig 2 [2]

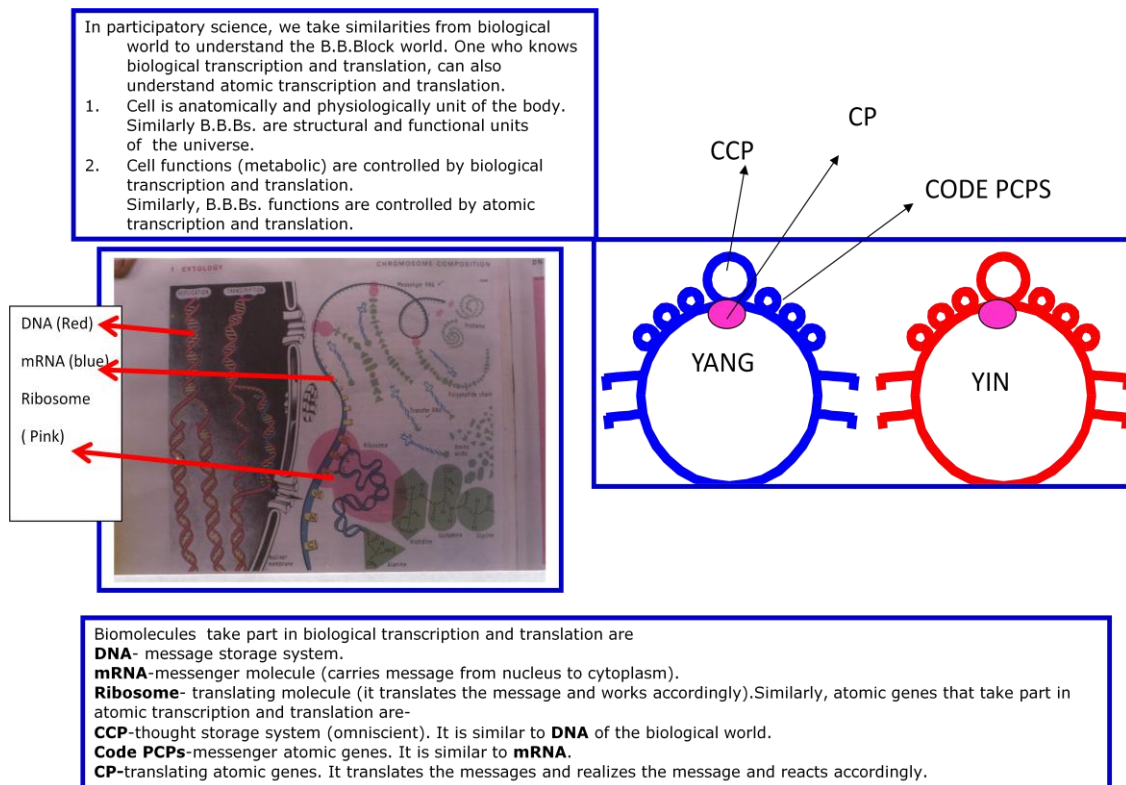
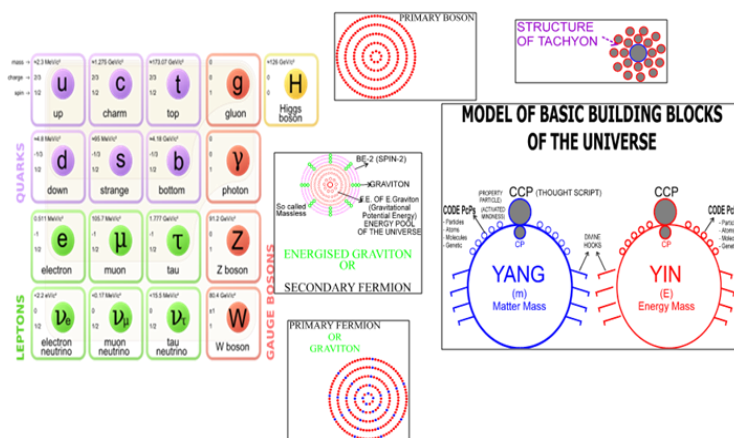

Fig. 2 Parallel teaching by participatory science

The standard model not only modified rather it has been completed [3] with introduction of energized gravitons , primary fermions, primary bosons , Basic Building Blocks , Mind and Tachyons as shown in Fig 3



Standard model completed with Fundamental particles and Mind And Tachyons

Fig. 3 standard Model chart [3]

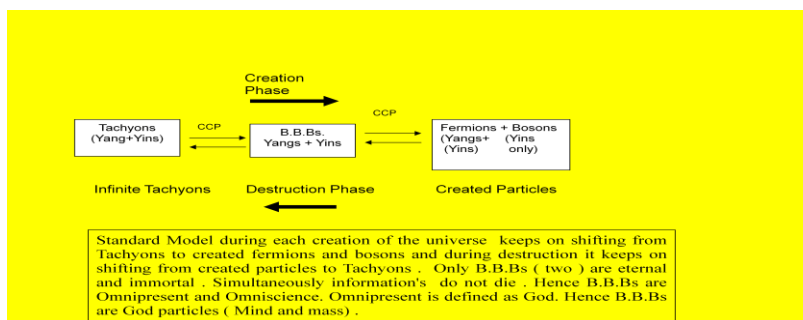

Fig.3.1 one creation and destruction cycle [4]

Participatory science has coined [5] some new words and there are some words which already exist in physics. Both these words are defined here and the definitions are according to participatory science. It has no relation with the definitions given in modern physics.

1. Mass - The part which gives shape to the smallest mass unit i.e. basic building blocks (B. B. Bs.) is called mass.

2. Matter :- Mixture of fermions and bosons or only bosons which are made up of mass (B.B.Bs) and that is why we realize their shape is called matter.

3. Inertial mass :- Mass (smallest mass units i.e. B. B. Bs) having inertial properties (classical inertia) either absolute rest or uniform motion in straight line is called inertial mass. Or Number of B. B. Bs. Per unit space present in bigger units is called inertial mass. Or Total matter contained by the bigger units or total number of fermions and bosons contained by the bigger units is called inertial mass. Therefore it never changes from place to place.

4. Gravitational mass :- The mass (interacting surfaces) which takes part in gravity (divine energized gravitons theory) interaction (which is due to mind) is called gravitational mass. When gravity interaction increases (number of divine energized gravitons increases) the interacting mass (interacting surface) also increases or when interacting mass (interacting surfaces) increases, gravity interaction (number of divine energized gravitons) also increases. Therefore gravitational mass (interacting mass or surfaces) changes from place to place. It is the fed mind that decides gravity interaction. We shall discuss it in gravity chapter and in atomic genetics.

5. Pure m (matter) mass :- matter mass (smallest mass unit or B.B.B) which have got inertial property of absolute rest.

6. Energy mass:- Energy mass (smallest energy mass unit B.B.B) which have got inertial property of uniform motion in straight line and which also gives shape to the bigger energy mass (Higgs Bosons etc) units.

7. m (impure matter) of $E=mc^2$:- Matter particles (fermions) which have got spin property are called impure matter particles.

1.4 Prayer message formation in brain.

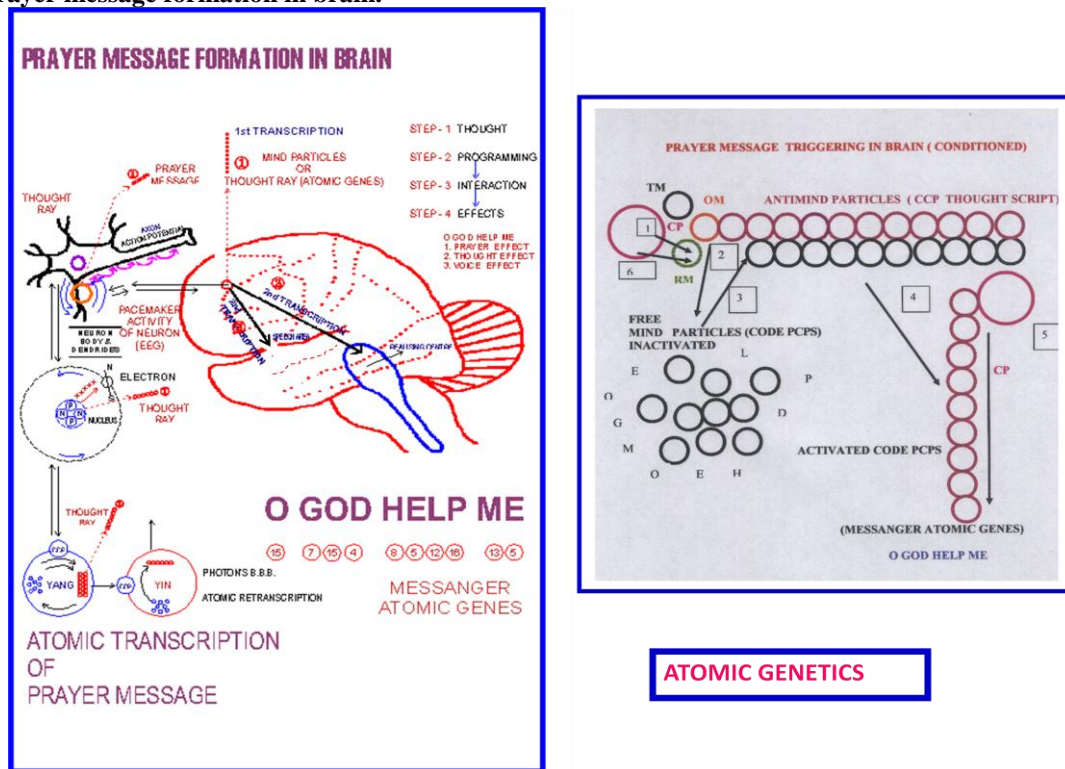

Fig 4 Divine Mechanics - Prayer message formation in brain

In atomic transcription and translation of prayer [5], following steps take place on Yang B.B.B – B-Bit as shown in Figure 4.

- 1.CP removes RM (repressor mindness-green) from OM (operating mindness -orange) thus induction of atomic transcription triggers.
- 2.OM triggers activation of free mind particles (black -inactivated code PCPs) of that thought script (magenta) of “o god help me ”.
- 3.Free mind particles (black -inactivated code PCPs) get attached to anti mind particles script (magenta one) to form messenger thought script of “o god help me ”.
- 4.Messenger atomic genes (black) get activated by anti mind particles thought script and further they get detached from anti mind particles thought script to form activated messenger atomic genes (activated code PCPs) (magenta) of “ o god help me ”
- 5.CP carries phenomenon of splicing by translating the messenger activated atomic genes (activated code PcPs) and finally there is activated message of “ o god help me” is formed .
- 6.CP represses atomic transcription by adding RM (green) to OM (orange) . Thus atomic transcription gets halt.

Having formed the message it comes out in three forms .

In atomic genetic engineering (prayer) we use our basic power i.e. power of B.B.Bs. Our B.B.B. (higher center) talks with highest center of the universe by sending the message by first transcription. Till today nobody knows how does the brain generate thoughts. I am going to tell you that mystery too. In the frontal lobe the neurons are responsible for thought generation. In the neuron there is electrical activity called pacemaker activity which is occurring between dendrites and the body of the neuron. The membrane of the cell is made up of atoms and atom is made up of B.B.Bs. At the level of B.B.B. say thought of 'O GOD HELP ME' is expressed. As a result programmed messages of O GOD HELP ME (code PCPs) are formed. Out of three programmed messages, one is carried by atomic genes to highest center of the universe. It is called **THOUGHT RAY (Quantum entanglement)** which is made up of pure atomic genes and then the message goes through phenomenon called first transcription. They come out from brain directly. The other two messages are carried by photons from nucleus of atom to electrons. Here they are modulated on electrical activity of the cell called pacemaker activity. Further they are modulated on actions potentials going towards **REALIZING CENTER** situated in brain stem (RAS) and from RAS to speech area situated in the frontal area. Target B.B.Bs. of the realizing center finally realizes thought effect of O GOD HELP ME. While from speech area message goes to

motor cortex again via RAS and from there to vocal cords and finally it comes out as a speech effect of O GOD HELP ME. In layman's terminology formation of the thought ray means PRAYER as shown in Fig 4

Where Does Prayer Message go ?

Prayer message goes as shown in Figure 5 to highest center of the universe via first transcription where it is realized and it is accepted, the highest center sends two messages to B.B.Bs working as higher center in cancer cell. These messages are message of inhibition of abnormal thought expression and message of activation of normal thought expression. Having received the messages, higher center stops expressing the abnormal thoughts and it starts expressing the normal thoughts. As a result, there are no more abnormal programmed messages and in place of that normal programmed messages are there. Now the messages have shifted from abnormal (5 and 6) to normal (2 and 3). This shifting of thought expression is called **ATOMIC**

GENETIC ENGINEERING as shown in **Figure 4.1**

The changed messages reach to target B.B.Bs. through same route. Having received the changed messages, target B.B.Bs. stop expressing the previous programming and they start expressing the normal programming. As a result the cancer cells transmutate into normal cells. **Or diseased cell gets cured [6]** as shown in **Fig 4.1.**

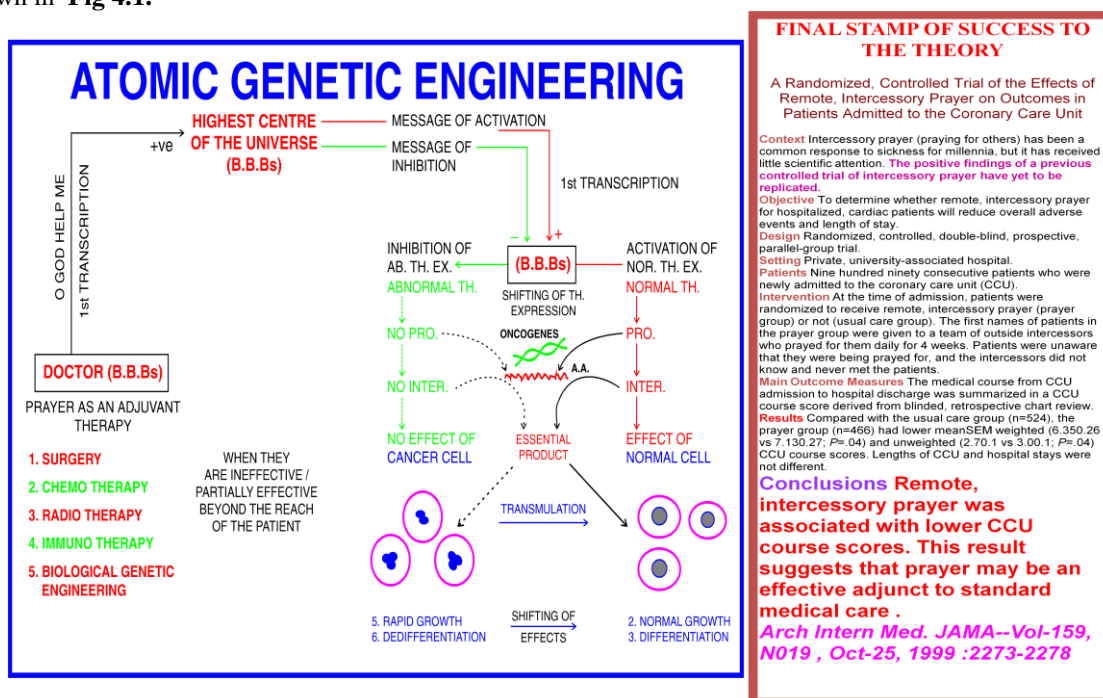

Fig . 4.1 A.G.E and Final stamp of success to New Theory[6]

1.5 Message system of the Universe

Before the origin of the universe [2] nature had only one type of message systems which is called **FIRST TRANSCRIPTION**. Messages (Code PcPs) used to go from one B.B.B. to another B.B.B. by atomic transcription. Messages were carried by atomic genes (Code PcPs) with very very high velocity. It is the fundamental message system.

After the origin of the universe, nature created atoms. It also created one more message system called **SECOND TRANSCRIPTION**. Here the message (code PcPs) are carried by photons from one atom to another atom with velocity of light. Thus atoms ,molecules, cells, and even individuals talk with one another

After the formation of the cell , nature created one more system called **THIRD TRANSCRIPTION**. Here there is a message storage system formed by DNA. There are messenger molecules called mRNA that carry message from DNA script to cytoplasm where the message (code PCPs) is read or translated by ribosome and they work accordingly. Thus the messages reach to enzymes and hormones and finally messages reach to target units. Having received the messages, target units work accordingly. Finally life effects (metabolic) are observed.

These three types of message systems are working in the nature. These message system are being used by the nature according to nature's need. as shown in Fig 5

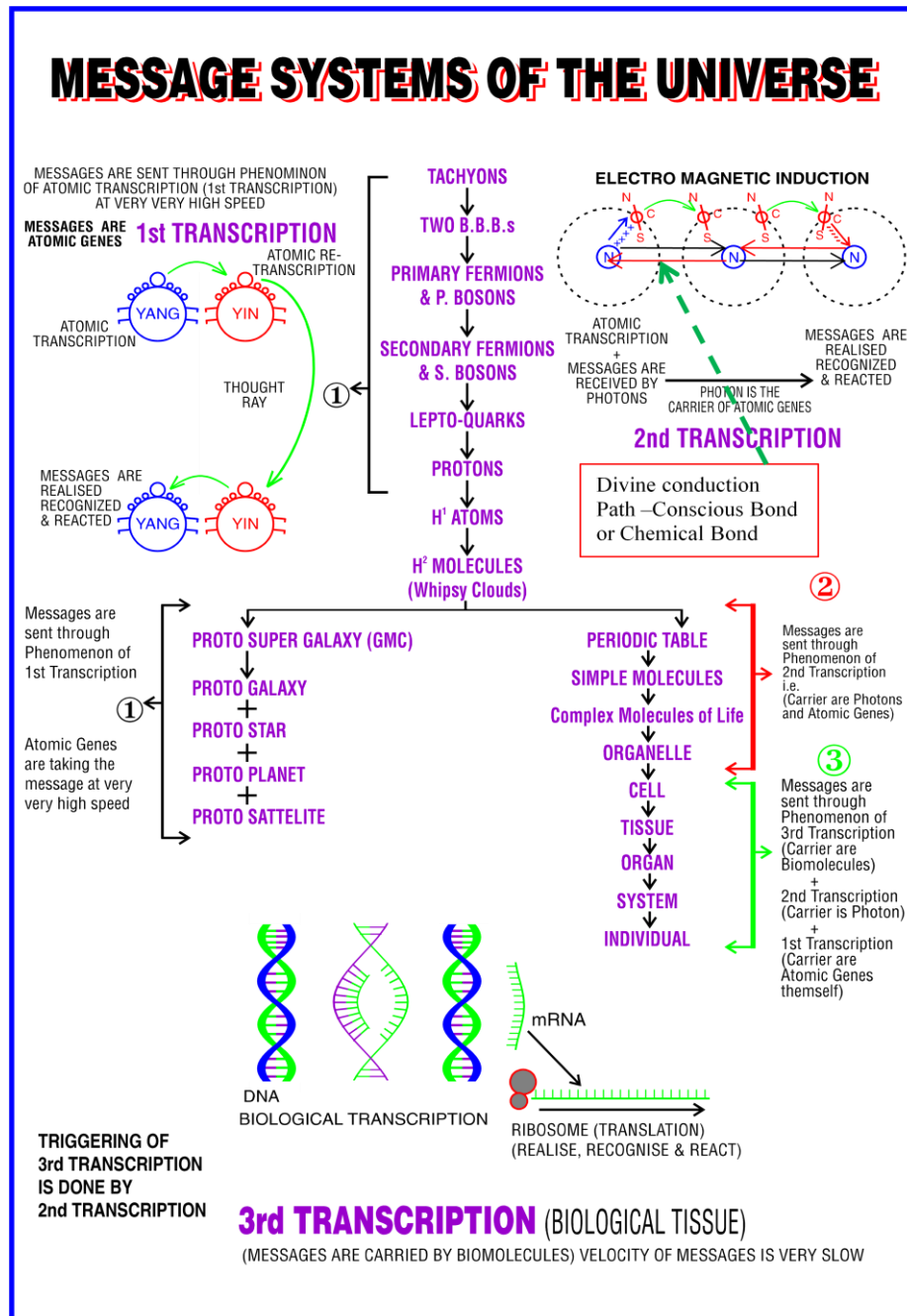

Fig. 5 Messages system of the universe

1.6 How does nature work & triggering of normal & abnormal effects

To understand creation physics as shown in Fig 6 and Fig 7. . There are two types of thought stimulation [2] . One is **CONDITIONED THOUGHT STIMULATION** and other one is **UNCONDITIONED THOUGHT STIMULATION**.

STIMULATION OF THOUGHT EXPRESSION --- There are two types of thought expressions one is **CONDITIONED STIMULATION** of thought expression, and other one is **self stimulation of thoughts** i.e. **UNCONDITIONED STIMULATION** of thought expression .

At the time of the origin of the universe, all effects got created. The cause of all effects of the universe is **THOUGHT** expression. These thought expressions were triggered by **UNCONDITIONED OR SELF STIMULATED WAY** . It is the first step and it is followed by **PROGRAMMING** or formation of programmed messages by code PCPs. This programmed message moves from higher centers to target B.B.Bs. it is called **INTERACTION**. Having received the messages, the mind and mass of the target B.B.Bs. work in a synchronized way so as to produced the effects as thought by a the higher center. If the thought expression by

higher center is normal, the shapes, properties and laws produced by target B.B.Bs. would be normal and if the thought expressions are abnormal, the shapes, properties and laws would be abnormal. This is the basic concept of transmutation phenomenon. Finally what we observe is called EFFECT. Appearance of new shapes, properties and laws is called TRANSMUTATION. The first three steps are collectively called CCP. During transmutation process if CCP is written, it does mean that unless the thought, programming and interaction take place, nature cannot transmute. Transmutation phenomenon is seen in particles, atoms, molecules and even in cells. The basic steps of any transmutation remain the same except that the thought expressions differ.

The subatomic particle are made up of more fundamental particles called Basic Building Blocks (B.B.Bs) which are made up of mind and mass. These B.B.Bs are divine in nature with the result they talk with each other by phenomenon called atomic transcription and translation (thought expressions). The triggering of broken symmetry is caused by atomic transcriptions. Unless the atomic transcriptions occur, subatomic particles could never exhibit phenomenon of broken symmetry . So the broken symmetry is never spontaneous. It is being mis understood that sub atomic particles do have spontaneous activities as far as broken symmetry is concerned. Hence the Nobel prize physics 2008 awarded to this work is too early to give prize.

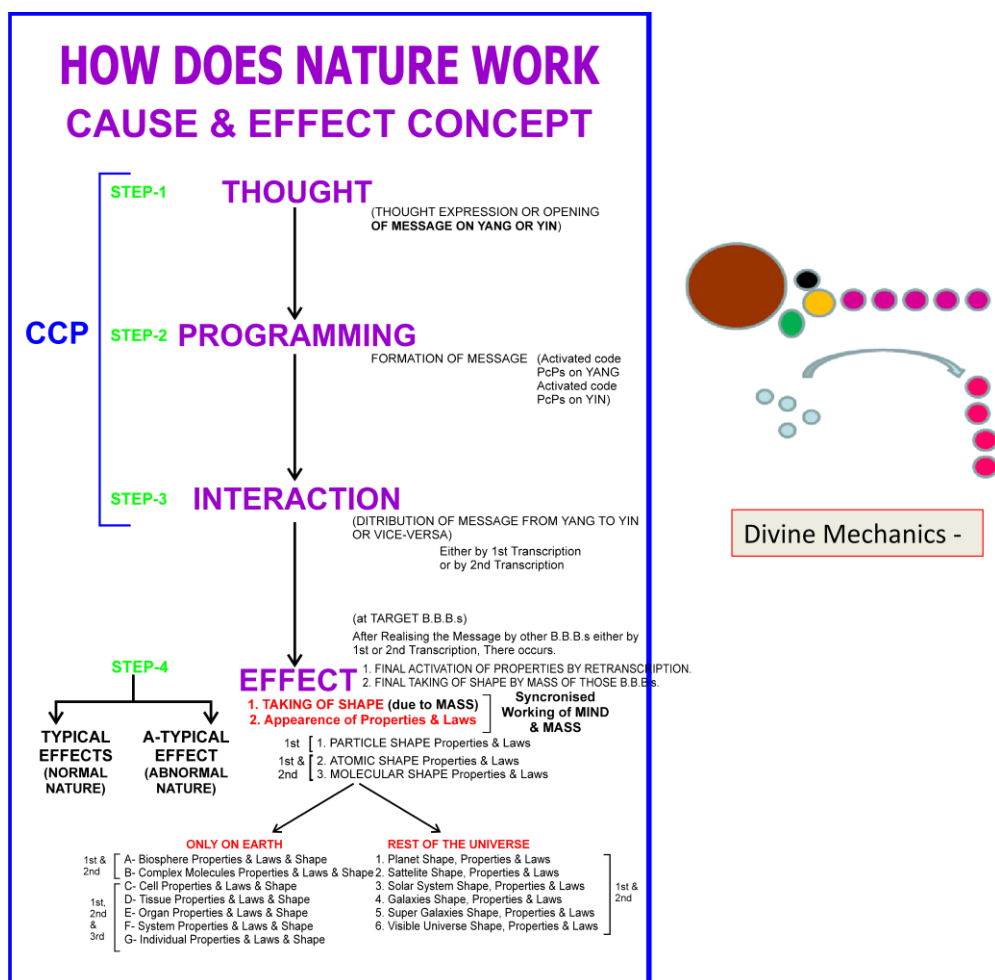

Fig. 6 Divine Mechanics – How Does Nature work ?

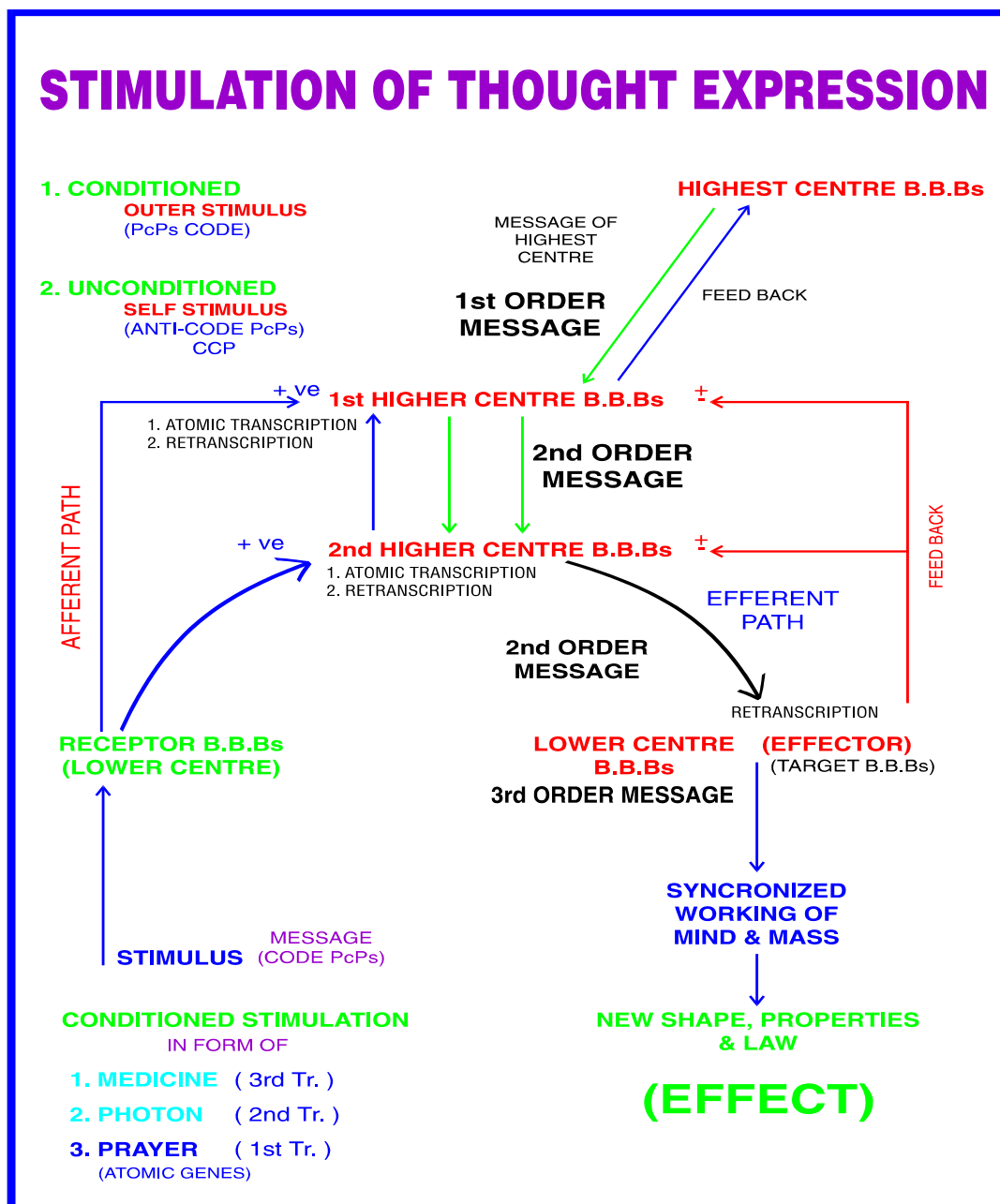

Fig. 7 Conditioned and Unconditioned thought expressions

1.7 Message network of the Universe (Feed Back Mechanism and different centers of the Universe)

With the origin of universe, nature first created primary units i.e. primary fermions (gravitation) and primary boson, these primary units are equipped with one higher center (one B.B.B.) and rest of the B.B.Bs. are working as lower centers or target B.B.Bs.[2] After primary units ,nature created secondary units i.e. secondary fermions and secondary bosons. similarly nature created tertiary units (lepto-quarks) and then quaternary units (protons& neutrons).

Each unit is equipped with higher centers, lower centers and target B.B.Bs. After quaternary units nature created atomic units, molecular units, complex molecules of life units, organelle units, cell units, tissue units, organ units, system units and individual units. Each unit is equipped with higher centers, lower centers, and target B.B.Bs. Similarly nature created satellite units, planet units, solar system units, galaxy units, super galaxy units, dark matter layer unit. These units are also equipped with higher centers, lower centers and target B.B.Bs. Thus our universe is divided into different units and each unit is equipped with higher and lower

centers.

All higher centers are under control of highest center of the universe by efferent paths. This efferent path is made up of first transcription. Higher centers can send messages to highest center of the universe by afferent path or feed back path. Thus highest center of the universe is well informed about all effects of the universe. Messages can come from lower centers to higher centers and from higher centers to highest center of the universe via afferent path. The highest center of the universe can send messages to higher centers and from higher center to lower centers. There is an inter unit message network also which is made up of first, second and third transcription depending upon the nature's need. Thus the entire universe is under control of highest center of the universe. Highest center can change any programming programmed by it during pre creation era as shown in Fig 8

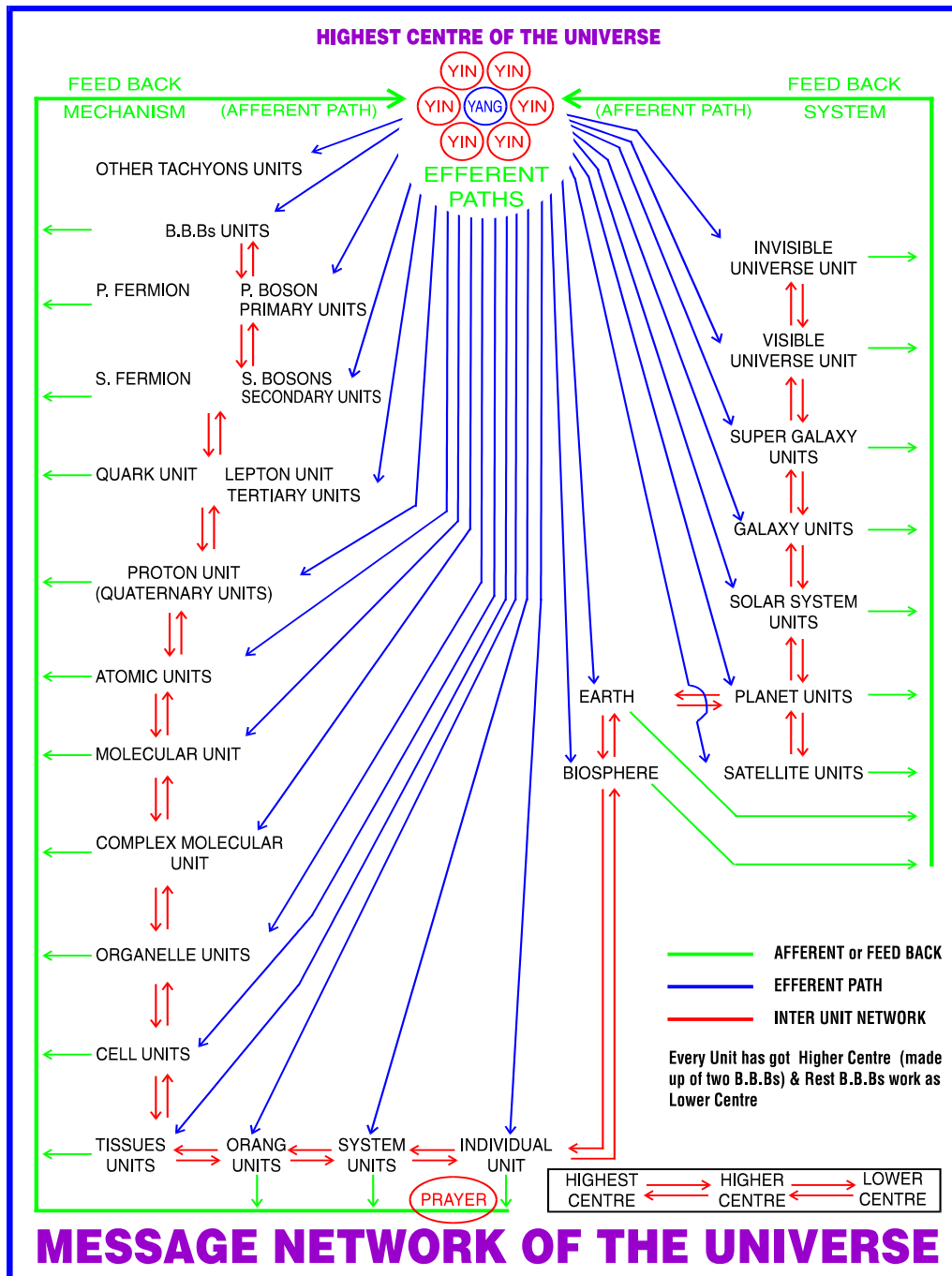

Fig. 8 Messages Net work of the Universe

1.8 Origin of the universe [7]

Hoyle – Narlikar Universe



ORIGIN OF THE UNIVERSE
CONTINUOUS CREATION THEORY—
 HOYLE AND NARLIKAR THINK THAT NEW MATTER IS BEING CREATED DUE TO 'IMPLOSION' TO BALANCE THE EXPANSION OF THE UNIVERSE, WHICH ASTRONOMERS HAVE OBSERVED. INSIDE 'QUASI STARS' GRAVITATIONAL COLLAPSES MAY FORM SOME MATTER IN THE UNIVERSE. THE HUGE LUMINOSITY AND THE RADIOEMISSION FROM THESE QUASI -STARS APPEAR TO BE 'GRAVITY POWERED' UNLIKE ORDINARY STARS WHICH DERIVE THEIR ENERGY FROM NUCLEAR REACTIONS

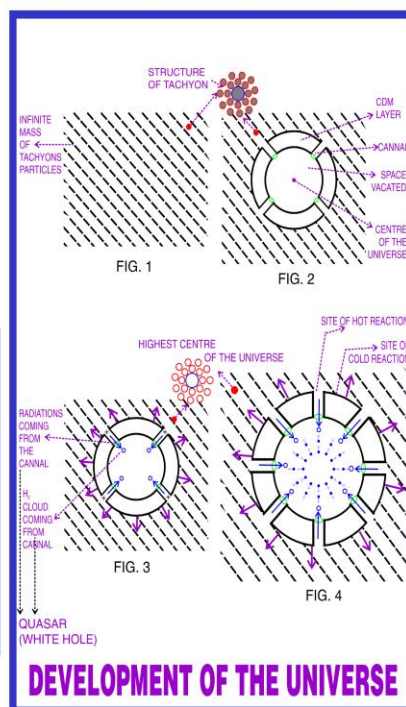

UNIVERSE "T"

Fig. 9 Development of the Universe

Before the origin of the universe, these Basic Building Blocks (B.B.Bs) as shown in **Fig-3** were in the form of tachyons as shown in **Fig- 9** [7]. It means that at that time the tachyons were everywhere in the universe. Let us look at the structure of tachyons; it is made up of one matter B.B.B. (YANG) and many energy (YINS) B.B.Bs. Initially out of the infinite tachyons, one became the **highest center** of the universe. Messages used to go from highest center to rest of the universe and messages could come from rest of the universe to highest center of the universe by atomic transcription. Thus highest center had fed its thought to rest of the B.B.Bs. that would take part in creation - that they would express only those thoughts to give desired effect as wished by the highest center of the universe. So all B.B.Bs were informed about their role before creation of the universe. In pre-creation era programming of the future universe was done by highest center of the universe. Our universe is oscillating and it is a divine universe. It means that it has a creation phase and a destruction phase. During creation phase tachyons break into their B.B.Bs. and from these B.B.Bs, formation of fermions and bosons take place as shown in **Fig 3.1**. After the creation phase, destruction would start and in this phase all created particles would again break into their B.B.Bs and finally tachyons would form. At the time of origin of the universe, all the effects got created. These effects are taking of different shapes and appearance of properties and laws. All these effects are studied in various branches of science.

With the origin of the universe, nature first created a sphere of **COLD DARK MATTER (C.D.M)** and canals in it. With the result space got created. At the other end of the canals, hot reaction started (**the relics are back ground radiations 2.7 degree K of our hydrogen clouds**). As a result hydrogen clouds and lot of radiations were created. The empty canals were filled by these hydrogen clouds and radiations and thus **QUASARS** appeared in the universe. Simultaneously C.D.M. layer started expanding and clouds and radiations kept on coming in this closed universe as shown in **Fig 9** . With the passage of time more and more C.D.M. layer formed, more and more quasars formed. The hydrogen cloud came in this closed universe. They started running towards C.D.M. layer as they were attracted by the gravity of C.D.M. layer. Those clouds, which were nearer, moved faster than those, which were away from CDM Layer. The **HUBBLE LAW**, can thus be explained. With some more passage of time, clouds were joined to form **GMC** (giant molecular clouds). Later

by self-gravitation different proto stars, proto planets, proto satellites were formed. Finally stars became bright and thus bright galaxies appeared in this universe. Our universe is still in expansion phase and creation is still going inside quasars. It is to be remembered that highest center of the universe does not come in the visible universe. It keeps on receiving the messages by atomic transcription and it has power to change any programming programmed by it during pre-creation era.

It is the atomic genes which constitutes mind part of reality. Mind incorporation in physics is awaited as theory of every thing is not yet investigated . I have investigated theory of every thing (ToE) and I found that while studying unified theory at the time of origin of the universe by Hoyle Narlikar universe , it was mind reality that triggered symmetry breaking phase . It is mind reality that triggers oscillation phenomenon of the universe. It is the mind reality which is behind perfect cosmological principle . There is nothing like artificial intelligence in the universe . These mind particles constitute intelligence of the universe that controls the deterministic order of the universe. It is the mind reality behind all effects of the universe. But this is not our mind rather it is mind of Almighty B.B.B (Yang B.B.B or matter B.B.B. or Male B.B.B working as Highest center of the universe) . His mind could be manipulated by prayer only . as shown in figure 9.1 and 9.2

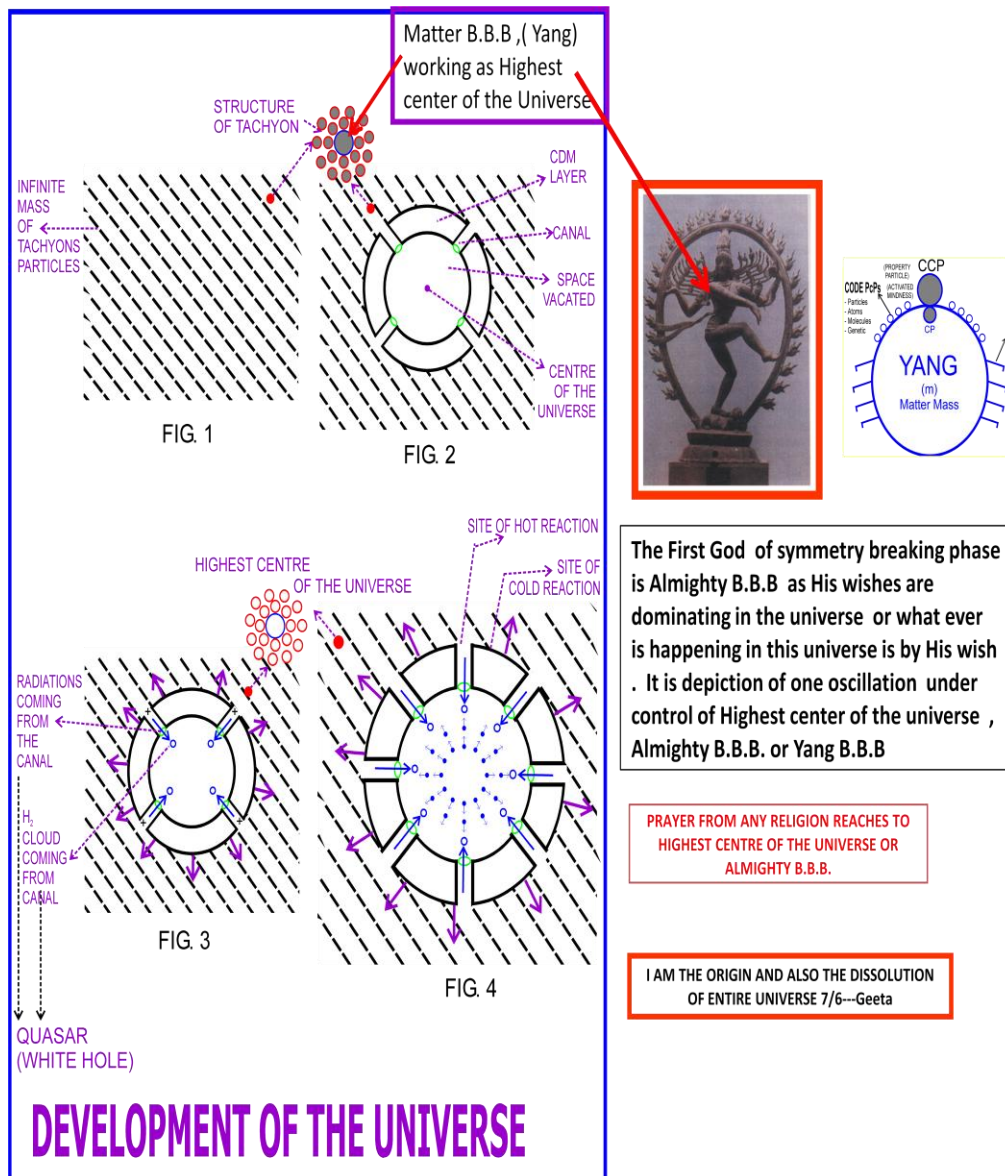

Figure 9.1 Hoyle Narlikar Universe OR Universe “I”

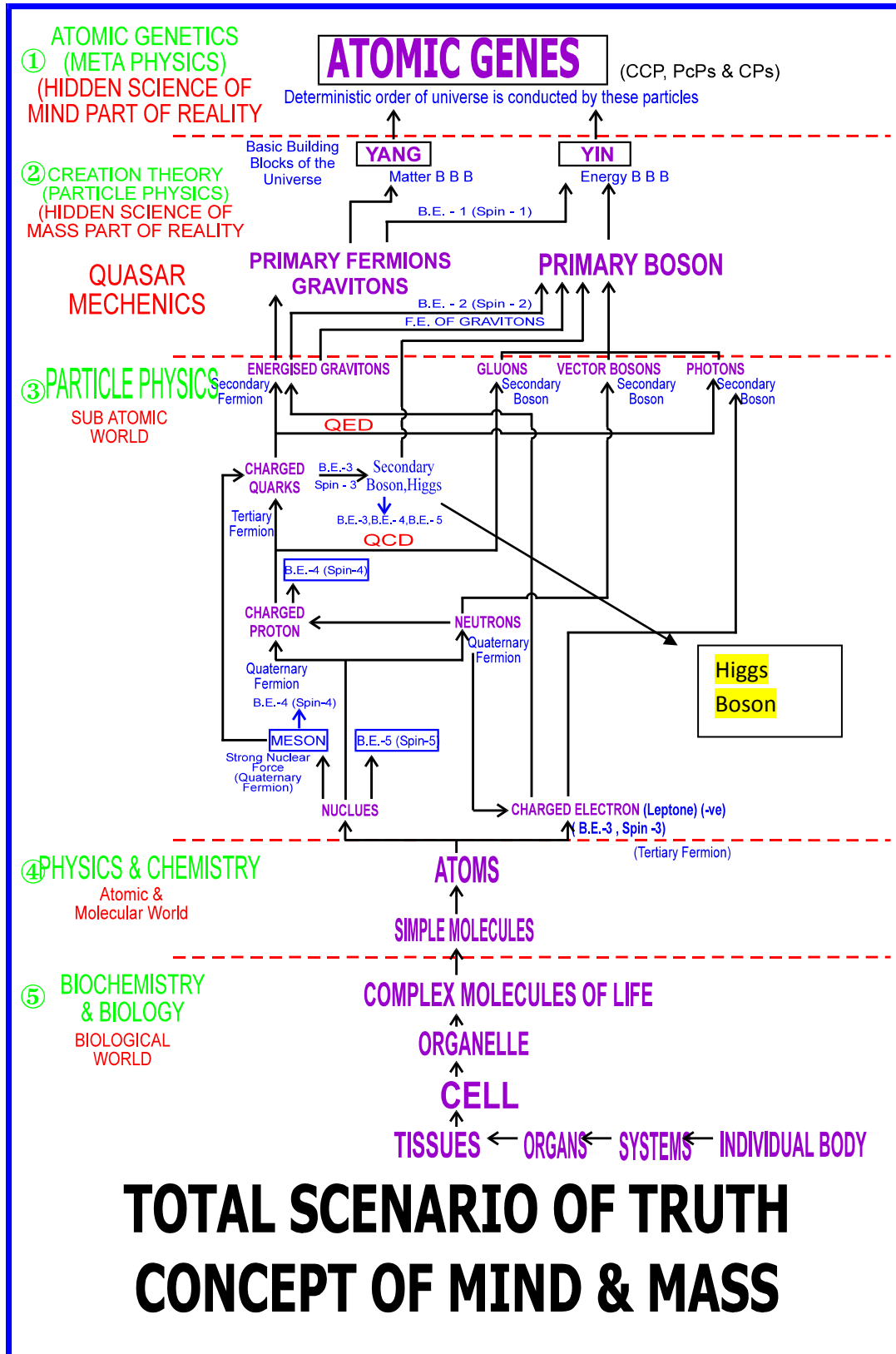

Fig 9.2 Total scenario of Truth Mind and Mass

1.9 DM and DE i.e. energized gravitons and energy pool of the universe as shown in Fig 10 and Fig 11 [8]

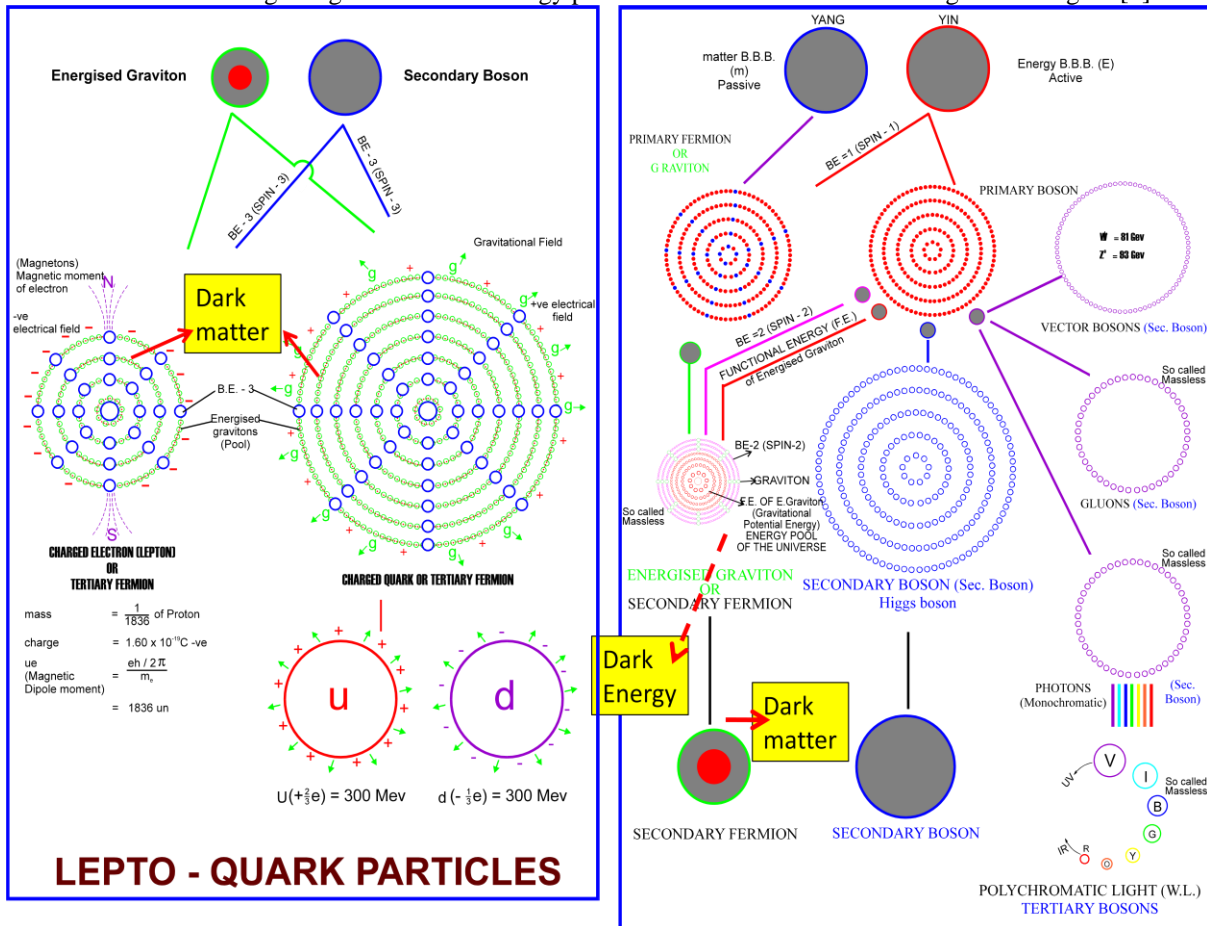

Fig. 10 Structural configuration of Leptons and Quarks as regard DM and structural configuration of DM and DE at micro level

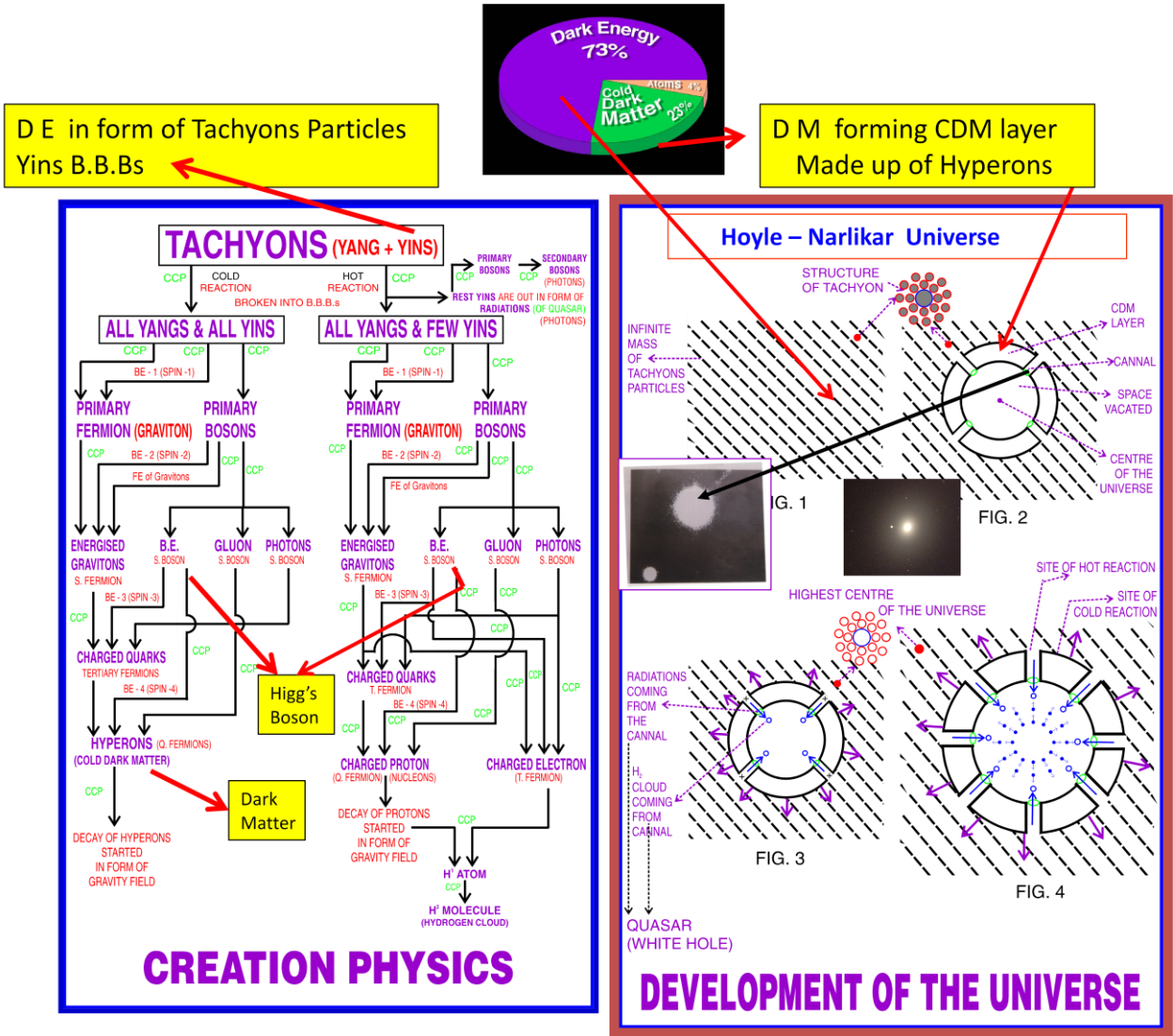
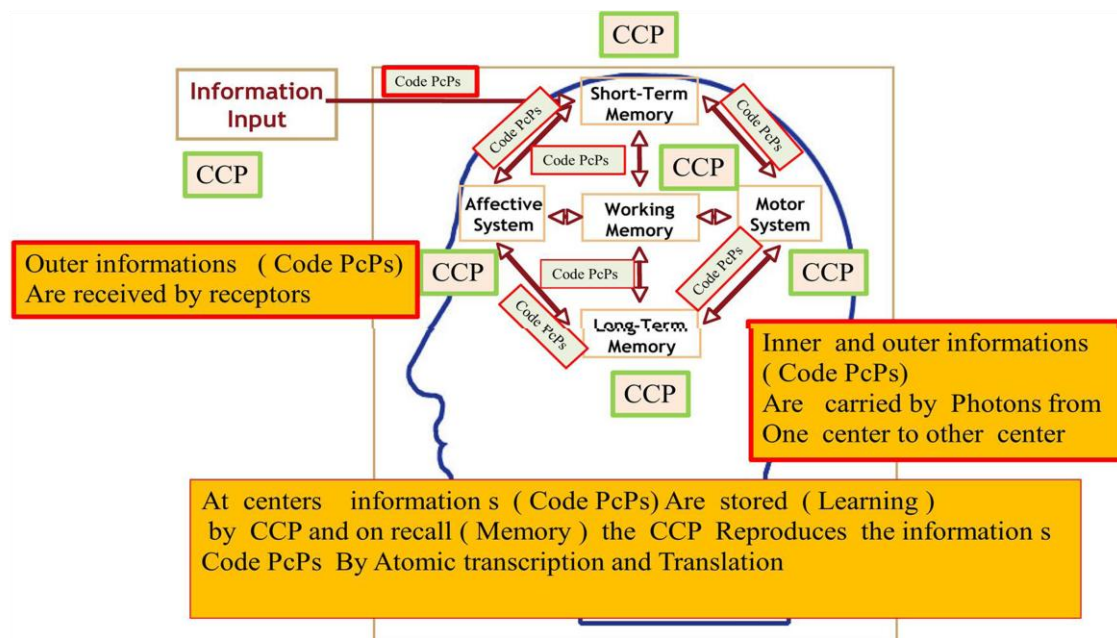

Fig 11 structural configuration of DM and DE at macro level [9]

1.10 Divine Mechanics and Brain Computation

Learning and Memory and information s (Code PcPs) Net work in Brain [10]



Divine Mechanics and Brain Computation

Fig 12 Divine Mechanics of Brain Computing System – Learning and memory

At all steps , these are B.B.Bs (B-Bit) that are responsible for information's control and triggering . If CCP is written it means unless atomic transcription and translation occur , brain cannot have learning and memory triggering and control and it is called Divine mechanics of Biology and it is life . These are higher thought expressions of B.B.Bs . In Bits of classical computers and qubits of QC , the thought expressions are lower and different but the mechanics (DIVINE) remains the same. as shown in Fig 12

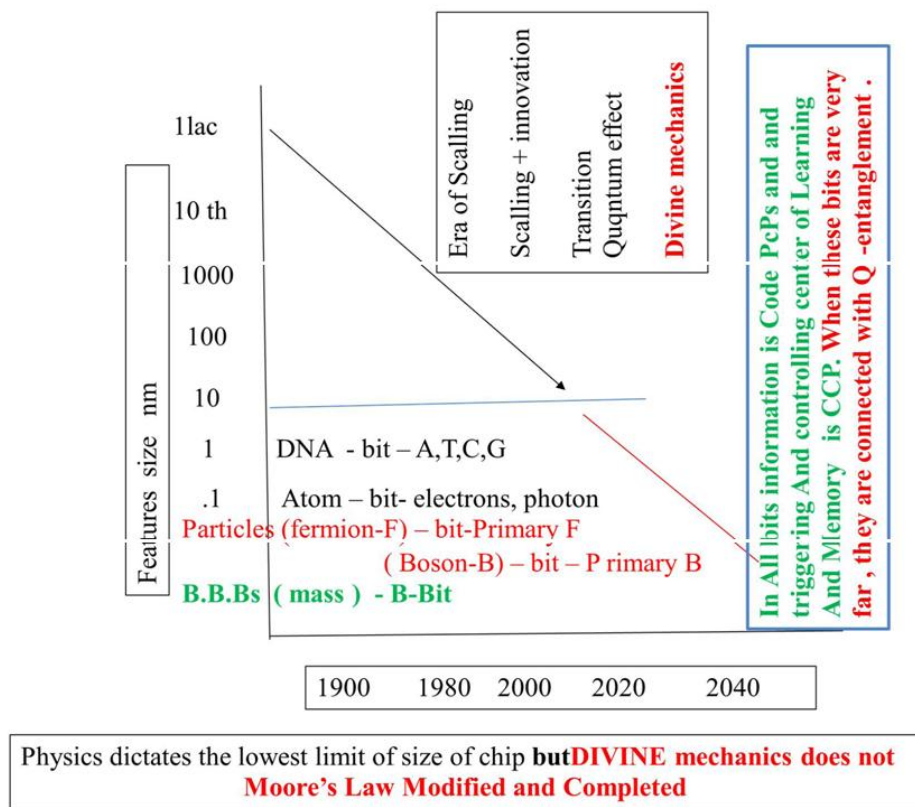

Fig 13- The Theory of Computers and Brain are same – DIVINE MECHANICS

(Structural and Functional smallest Bit (mass) is B-Bit of the universe and the Divine Mechanical Unit is CCP , Code PcPs and CP.)

DIVINE MECHANICS The Theory of Computers and Brain is SAME as shown in Fig 13

Physics dictates the lowest limits of the size of chips [11]. But divine mechanics does not . Hence the bit is a typical unit of information. ((Classical and Quantum Bit) is wrong and to describe informations by adding qubit is also illusion as in complicate system ,it is the different thoughts expressions that describe informations . Informations are separate (Code PcPs) and bits (Electron of transistor) qubits (electron of diamond crystal) are separate. At DNA level the bit is nucleotide (A,T,C,G) and at Atomic level the bit is photon and electron , at particle level (secondary fermions and secondary bosons) the bit is primary fermions and primary bosons and informations are still code PcPs and at B.B.B level the bit is B.B.B (Yang mass and Yin mass - B- bit) it self and the information is carried by Code PcPs but at all level of all bit units the information storage system is CCP (Physiological arrow of Time) it never dies even after destruction of the universe. Hence informations are eternal . In computers, Bit is a structural configuration that describes informations of the system and informations are in form of Code PcPs. The working of the bit is triggered and controlled by thoughts of higher centers that form that bit. If the bit is classical (transistors of chips) the effect is different . But if the bit is qubit with entanglement the working is triggered and controlled by thoughts of higher center that form that crystal . In both the effect of describing informations would be different.

One is classical (thought expressions are fixed and limited)and other one is quantum (thought expressions are changing and more wide to describe the more wide complicated system to have fast results .) . In life sciences in Brain the bit is again Photon and the informations are Code PcPs and they are triggered and controlled by CCP of higher centers that is triggered by DIVINE MECHANICS .

In life sciences the CCP (cryptography) of B-bit expresses informations (Code PcPs) which were not fed like speaking Lie and unlike Bit of classical computer and qubit of QC it shows phenomenon of forgetfulness and IQ phenomenon (mental age /real age) . It is Higher functions of B.B.B or B Bit and it is life . Hence there is difference in some aspect of DIVINE MECHANICS \of Computers computation and Brain computation

III. Structure

2.1 Modified theory of atomic structure as Niels Bohr's theory has limitations in explaining different series of hydrogen spectra.

New assumptions of structure of hydrogen atom. – Divine Modified Niels Bohr 's Theory (**Divine MONB**) as shown in Fig 14

1. Hydrogen atom is like a miniature solar system with the negatively charged electron moving in circular orbit around positively charged nucleus having positively charged particle proton. In this circular orbit or stationary orbits , electron is being held by single string of energized gravitons . This energy level is called ground state.
2. When Hydrogen atom is excited, the electron moves from ground state to excited state energy levels making a bigger circular orbit and having reached in this new energy levels , it also emits radiations . Hence absorption and emission of energy quanta occur simultaneously. Shifting is understood in inter orbital shift phenomenon.
3. When excitation is over, the electron once again come back to ground state energy level . All above mentioned events are triggered by different thoughts or atomic transcriptions from the nucleus or proton in case of hydrogen atom.
4. These atomic transcriptions are being triggered by conditioned stimulation of CCP by the message system made up of photons (second transcription or –ve charged photons or afferent path) coming from electron to proton and further they are transmitted by photons (second transcription made up of +ve charged photons, or efferent path) to electron. Having received the messages , electron works accordingly. Unless the thought is expressed, nature cannot work . as shown in Fig 14
5. When electron is in ground state, its interaction with energized graviton and electromagnetic photon is more hence IP -13.59ev (n=1) is required to remove electron from this energy level. During excited stage the interaction is different hence I.P. to remove electron from this state is -3.4ev (n=2), -1.511ev (n=3), -0.850ev (n=4) , -0.544ev (n=5) respectively. It the changing thought of interaction with energized graviton and electromagnetic photons that gives changing effect .
6. Electronic configuration of higher atoms could be known by studying I.P. curve . Working of hydrogen atom as shown in Fig 14 .

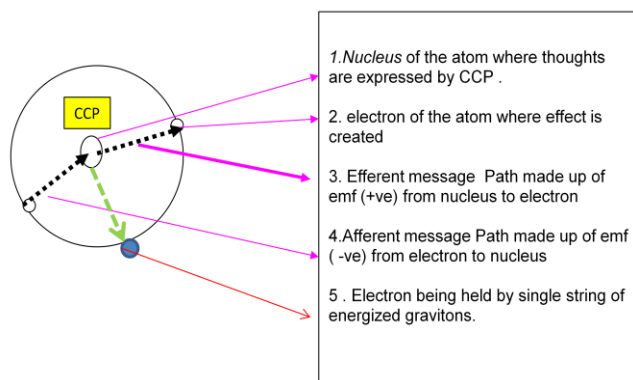

Fig 14 working of hydrogen atom – Divine MONB Theory

2.2 Origin of Earth and Species .

Evolution of species (animal and plant) is different phenomenon (unconditioned thought expression) and evolutionary molecular biology of enzyme and antibiotics (conditioned thought expression) is different . To understand origin of life , we have to understand origin of solar system .

ORIGIN OF THE EARTH AND SOLARSYSTEM

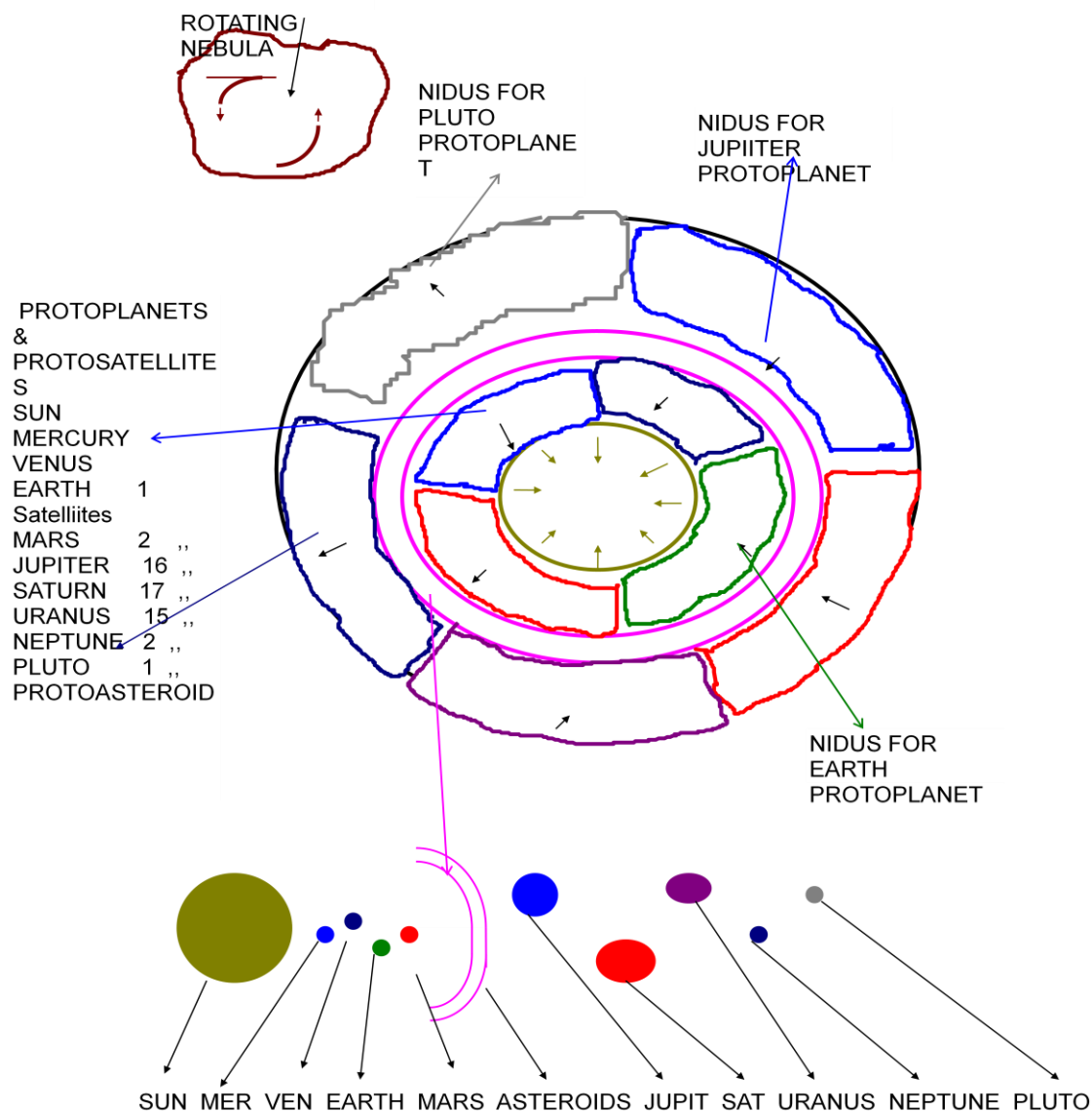

Figure -15 origin of solar system

Till today it is believed that earth is the part of sun and sun is second generation star. There are observations which contradict this hypothesis. After the formation of rotating GMC (giant molecular cloud), there developed many nidus (B.B.Bs working as higher centers) in the rotating nebula. These higher centers expressed thoughts of condensation of nebula in different sectors that will give rise to formation of proto stars, protoplanets, proto satellites and proto asteroids and thoughts of contraction or collapse that will cause shrinkage of proto star, protoplanets and proto satellite. The formation of asteroid belt is due to thought expression of clumping or collapse. Thus there developed many different sectors in same nebula. Along with this the spin thoughts were also triggered. This led to development of spin of proto star, protoplanets, proto satellites and proto asteroids. Finally the nebula transformed into proto star, protoplanets, proto satellites and proto asteroids. About 4.6 billion years ago, formation of our solar system took place. (Figure 15) In these proto star, protoplanets, proto satellites, proto asteroids many other different thought expressions were expressed by many other higher centers (B.B.Bs) that had led to formation of sun, different planets, different satellites and asteroid belt between mars and Jupiter. ALL ARE BORN FROM SEPARATE NEBULAR SECTORS AND THUS THEY ARE CREATED WHERE THEY ARE PRESENT NOW IN ORBIT. They all have their different

shapes, size, different properties, different compositions and behavior which were triggered by many different higher centers..The asteroid belt present between Mars and Jupiter was created from proto asteroid by phenomenon of clumping. THIS WAS ALL DUE TO UNCONDITIONED THOUGHT EXPRESSIONS OF B.B.Bs.(Figure 7)

Origin Of Continents And Shifting Of Continents

When the Earth was forming , there developed many other higher centers for different thought expressions. These were--

1. Thought expressions of formation of continents and water.
2. Thought expressions of formation of different layers of the earth.
3. Thought expressions of formation of different layers of atmosphere.

And thus Pangea continent, sea, different layers of earth, and different layers of atmosphere were formed by target B.B.Bs.

Simultaneously there developed other higher centers which expressed following thoughts--

1. Thought expression of ignition of the core
2. Thought expression of magma.
3. Thought expressions of shifting of continents.(Figure 16)
4. Thought expressions of seismic foci
5. Thought expression of water cycle

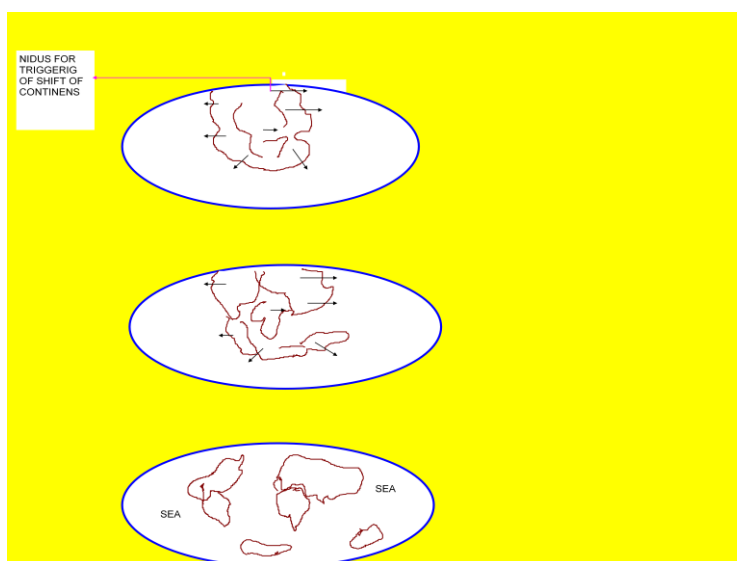

Figure 16 shifting of continents

And thus formation of heat in the core, magma in mantle layer, seismic foci in lithosphere (Figure 17), shifting of different continents in their respective directions and appearance of water cycle took place by different target B.B.Bs. This was all triggered by unconditioned working of B.B.Bs. The entire transmutation took place simultaneously

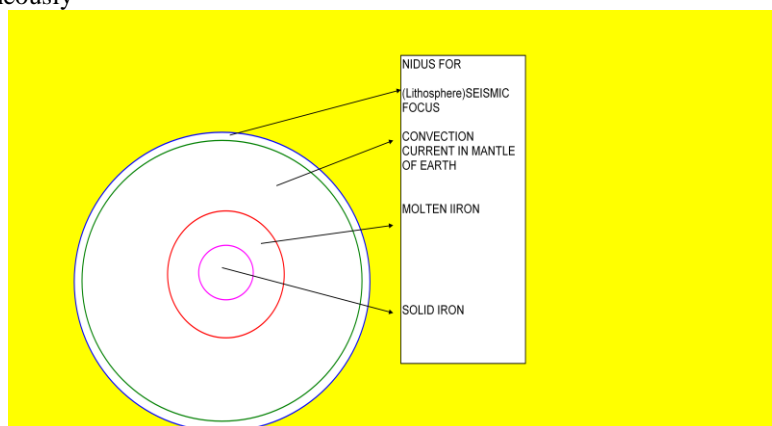

Figure 17 Nidus for seismic foci

Definition of life and death

Life is nothing but higher thought expressions of basic building blocks. When these thought expressions are inhibited and death thoughts are triggered we become dead.

First Organism Created Was Blue Green Algae

Pre-Cambrian stromatolites in the Siyeh Formation, Glacier National Park. In 2002, William Schopf of UCLA published a paper in the scientific journal Nature arguing that geological formations such as this possess 3.5 Ga (billion years old) fossilized cyanobacteria microbes. If true, they would be evidence of the earliest known life on earth. It was created by unconditioned thought expressions of basic building blocks involved in blue green algae formation. The process was like this . There became a higher center in the soil that expressed the thoughts of blue green algae. The message came out in form of code PCPs (second messenger) i.e. photon carried the messages to all target B.B.Bs . having received the messages , target B.B.Bs transformed into blue green algae . Once the blue green algae formed and the life processes started then by conditioned stimulus of thought expression reproduction triggered and it started multiplying by conditioned stimulation of thoughts .

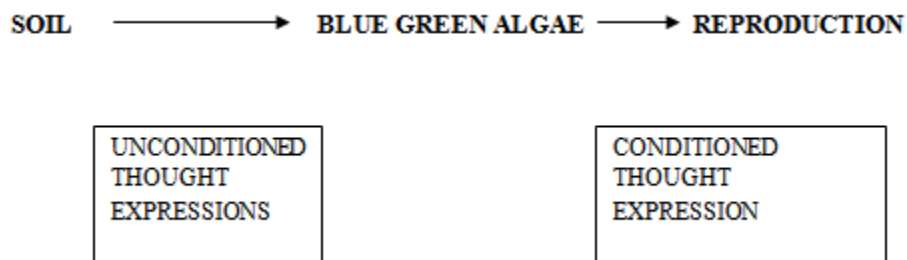

First time the life appeared by unconditioned thought expressions and later nature made the law that for offspring living parents are necessary and thus by conditioned thought expression for off springs, parents are required and hence we observe in living world reproduction whether sexual or asexual , parents are required to produce off sprigs.

The similar phenomenon had occurred in plant and animal Kingdome . In plant king dome first seeds were formed directly from soil by unconditioned thought expressions and later once the plant grew , then by conditioned thought expressions reproduction started . In animal Kingdome the same thing appeared . Parents were formed first directly from soil by unconditioned thought expressions and once parents were formed they started reproduction by conditioned thought expressions and it became a law that for offspring's previous living parents are necessary. Monkeys formed separately and homo-sapiece formed separately . Hence our fore fathers were not monkeys . During evolution, they were formed before MAN. Monkeys did not transform into human beings.

Conditioned Stimulation of Thought expressions in Plant Kingdom

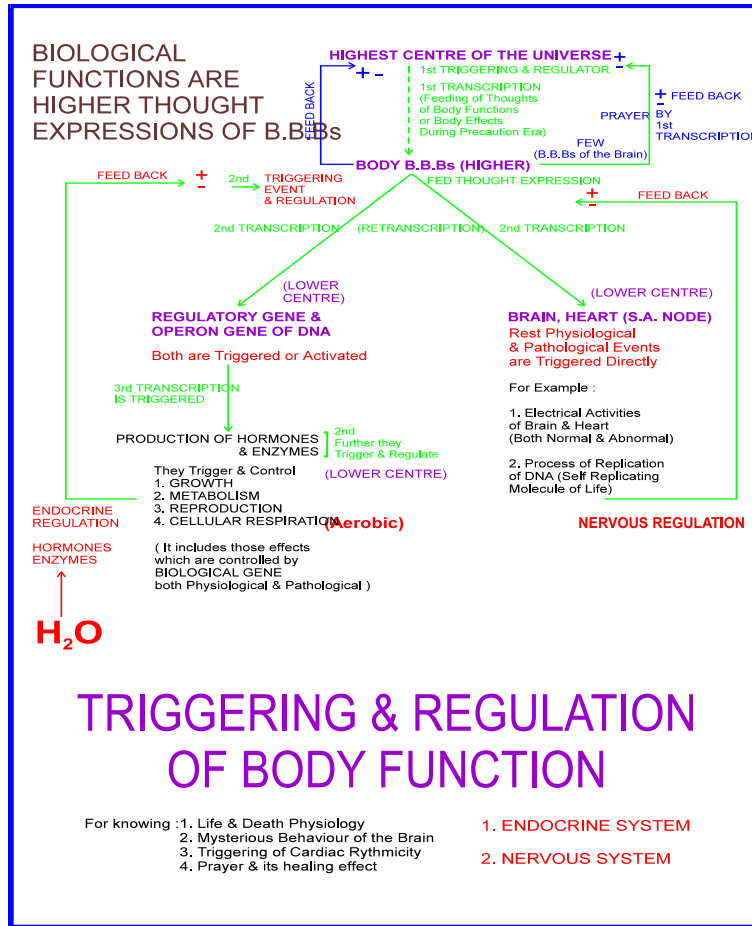

Figure 18 Conditioned stimulation of thoughts

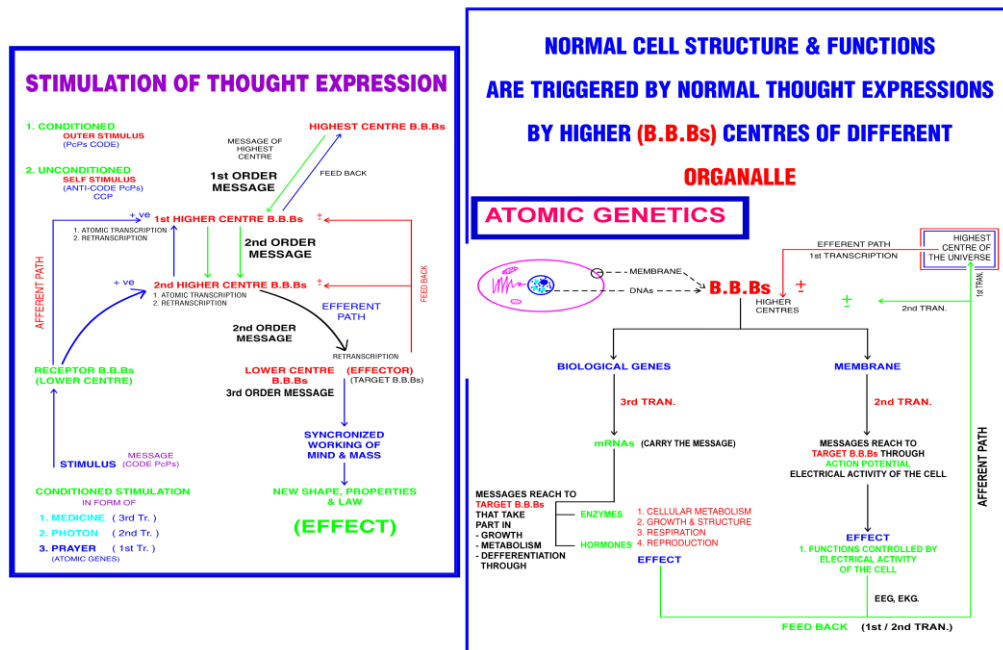

Figure 19 Life activities are triggered by thoughts

MICHANICS OF LIFE AND DEATH (Figure -18 and figure 19 , Figure 20)

Seed is alive (say having 1% of life activity) but hardly show any sign of life. It has low water content and exhibits virtually no metabolic activity. Such quiescent seeds can live for many years but germinate when soaked in water under suitable temperature and in presence of oxygen. Metabolic activity (anaerobic) are very

low in seeds. Metabolic activities come to visually standstill as the seed coat becomes increasingly impermeable to oxygen and moisture.

The first step in germination is **IMBIBITION**. Imbibition of water causes resumption of metabolic activities. Initially metabolism may be anaerobic (due to energy provided by the glycolysis) but it soon becomes aerobic as oxygen starts entering the seed.

What are life activities?

DNA Activities

- a. Transcription – that leads to first anaerobic metabolism later aerobic metabolism. It is very very low in seed .
- b. Replication – it is nil in seed. Replication is the sign of life. If seed does not show replication phenomenon, it means for practical purpose it is dead.

During germination anaerobic metabolism is triggered and later it is shifted to aerobic metabolism . Replication is also triggered. The triggering of both the activities is onset of atomic transcriptions of replication as well as onset of transcriptions of aerobic metabolism. With the result messages come on the surfaces of DNAs and during 3rd transcriptions they are shifted to different mRNAs and finally they reach to different enzymes and hormones. These enzymes and hormones carry messages to target units . With the result we observe phenomenon of germination. The entire working has been depicted by line diagram (**Fig –6**). These atomic transcriptions are stimulated by water that is why it is **CONDITIONED STIMULATION of CCP**. The percentage of thought expressions increase with the time and we observe increase in the number of effects. At present we can say that plant is showing from 1 % to 20% or 40% of its effect till it reaches its maturity . At maturity the plant exhibits all effects and at that time we can say it is expressing 100% life atomic transcriptions. With the formation of new seed life atomic transcriptions once again reduced to 1% only. This cycle i.e. going from 1% life effects or atomic transcription to 100% life effects and coming back to 1% again is being visible to us at present. When water is withdrawn, it leads to suppression of life thought expressions and death thought expressions are triggered with the result we observe death effects of plant.

CONCLUSION OF THE EXPERIMENT- The phenomenon of life effect is triggered by atomic transcription of life. Unless life atomic transcriptions are triggered, life effects are not visible. So life effects are nothing but higher thought expressions of basic building blocks. Phenomenon of death is triggered by death atomic transcription. At the time of death life thought expressions are inhibited and death thought expressions are triggered with the result we observe death effects. Water only stimulates life thought expressions that leads to triggering of different life activities (metabolic , replication and other electrical activities) in side the cell. Being a scientist, one must know how do life effects come about. Life effects are higher thought expressions of B.B.Bs. Formation of particles, atoms and molecules are due to lower thought expressions of B.B.Bs. But their higher thought expression lead to appearance of all life effects. One who knows properties of B.B.Bs. and atomic genetics, can understand how life effects are triggered. There is nothing like **SOUL**. **It is a myth** that when soul goes inside we get life and when it moves out we are dead. When thought expressions of life are suppressed and thought expressions, of death are triggered, we observe death effects. So life effects are basically triggered by atomic transcription occurring on B.B.Bs.

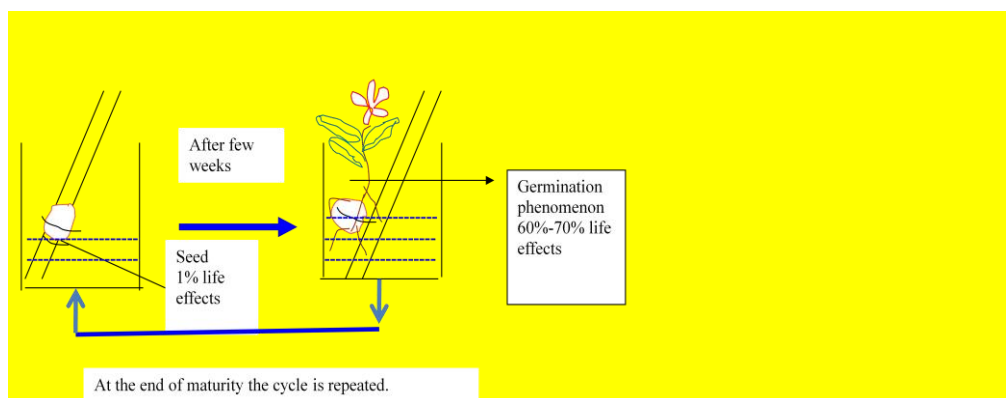
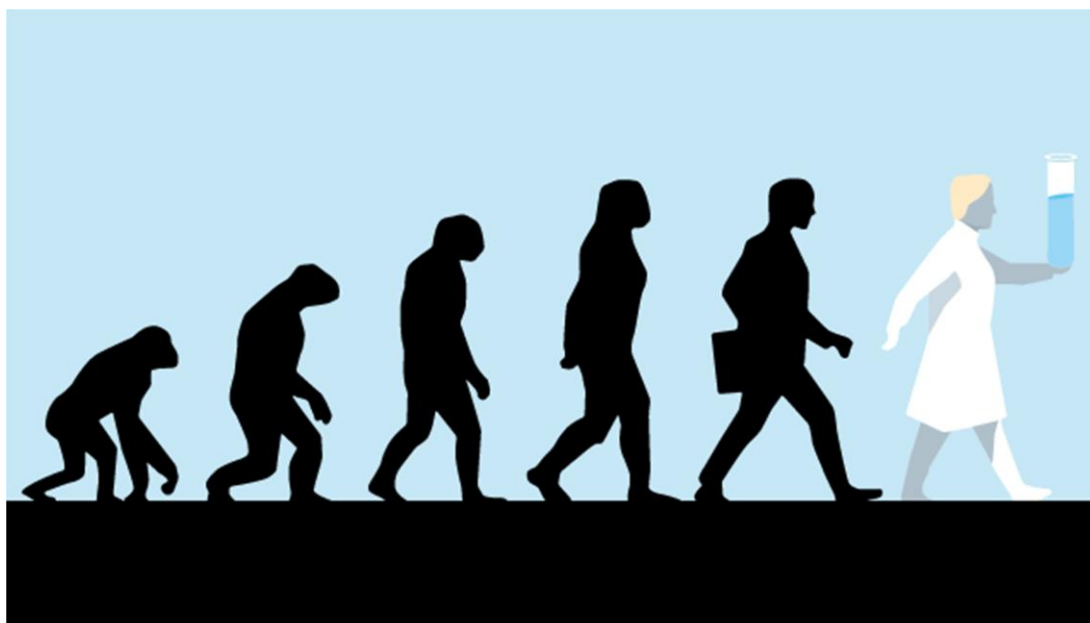

Figure 20 Phenomenon of Germination

1. It is believed that There are two possible sources of organic molecules on the early Earth: a. Terrestrial origins – organic synthesis driven by impact shocks or by other energy sources (such as ultraviolet light or electrical discharges) (e.g. Miller's experiments) b. Extraterrestrial origins – delivery by objects (e.g.

carbonaceous chondrites) or gravitational attraction of organic molecules or primitive life-forms from space (see Panspermia) It is all myth and illusion.

2.It is believed that human and apes shared a common ancestry –



Evolution of Man It is all MYTH and illusion

Figure 21 Evolution of Man It is all MYTH and illusion

At the end of 1859, Darwin's publication of *On the Origin of Species* explained natural selection in detail and in a way that lead to an increasingly wide acceptance of Darwinian evolution. Thomas Henry Huxley applied Darwin's ideas to humans, using paleontology and comparative anatomy to provide strong evidence that humans and apes shared a common ancestry(figure 21) . It is all MYTH and illusion

3.It is believed that multi cellular were originated from unicellular –

The history of life was that of the unicellular eukaryotes, prokaryotes and archaea until about 610 million years ago when multicellular organisms began to appear in the oceans in the Ediacaran period.^{[253][260]} The evolution of multicellularity occurred in multiple independent events, in organisms as diverse as sponges, brown algae, cyanobacteria, slime moulds and myxobacteria.^[261] Soon after the emergence of these first multicellular organisms, a remarkable amount of biological diversity appeared over approximately 10 million years, in an event called the Cambrian explosion. Here, the majority of types of modern animals appeared in the fossil record, as well as unique lineages that subsequently became extinct.^[262] Various triggers for the Cambrian explosion have been proposed, including the accumulation of oxygen in the atmosphere from photosynthesis.^[263] About 500 million years ago, plants and fungi colonised the land and were soon followed by arthropods and other animals.^[264] Insects were particularly successful and even today make up the majority of animal species.^[265] Amphibians first appeared around 364 million years ago, followed by early amniotes, then birds around 155 million years ago (both from "reptile"-like lineages), mammals around 129 million years ago, homininae around 10 million years ago and modern humans around 0.25 million years.

It is all myth and illusion . Both were originated separately from soil and by unconditioned thought expressions. No doubt unicellular appeared first and multicellular appeared later. It was the TIME mindness that regulated their time of appearance on earth. It is also fed time mindness and feeding was done in precreation era by highest center of the universe.

4.It is believed that there is soul that is required to evolve life . It is all myth and illusion. Whether it is unicellular or multicellular or plant kingdom or animal kingdom , it was thought expressions that triggered life process . See Figure 18 and Figure 19 above. First time the life process was triggered (different structures and functions) by unconditioned thought expressions and later the law shifted to conditioned stimulation of thought expressions . These are all fed thoughts (both unconditioned and conditioned) and feeding was done in precreation era by Highest center of the universe.

5. Life effects are nothing but higher thought expression of B.B.Bs. Formation of atoms and particles are due to lower thought expressions . During the origin of life , it was unconditioned thought expressions that lead to formation of first life i.e. green blue algae on earth. . It was due to fed thoughts and feeding was done in pre creation era by Highest center of the universe . . Highest center has only power to trigger same phenomenon by unconditioned working of nature as It did 3.5 billions years back when first life appeared on earth by formation of blue green algae. If this prediction gets true , the entire hypothesis would be confirmed and dead cells could be made alive.

Law Of Independence.

It is being observed that some type of life depends upon other type of life . As animals do depend upon plants. Hence the plants appeared first and animals created later on . Similarly , in animal kingdom parents created first by unconditioned thought expressions and eggs came by conditioned thought expressions by sexual method. This also completes the quiz of whether egg appeared or hen . Because egg requires hatching (warming by parents) before it transform into hen. Similarly seeds are more independent structure than a plant . Because plants depend upon water , air and soil .But seeds could live independent of years together without air , water and soil. Those plant that do not produce seeds came directly by unconditioned thought expression . And later they produce off springs by sexual or asexual method . For example --Fern and moss

2.3 Mind underpins all behavior of Photon (Laser) like amplitude magnification with amplitude modulation to make high intense laser .

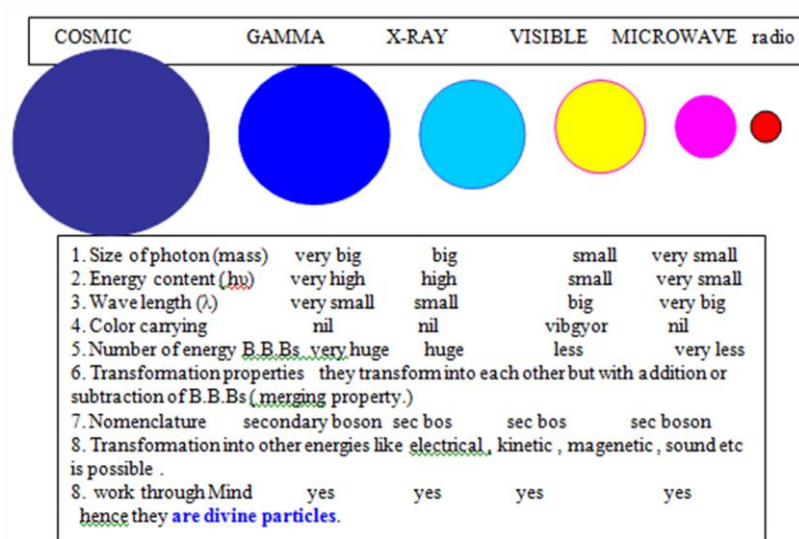

Oscillation Property of Bosons

Figure 22 Structure of Gamma , Xray , visible rays and microwave and radio and oscillation property of photons

Atomic genetics and phenomenon of amplitude modulation of laser beam (micro level)

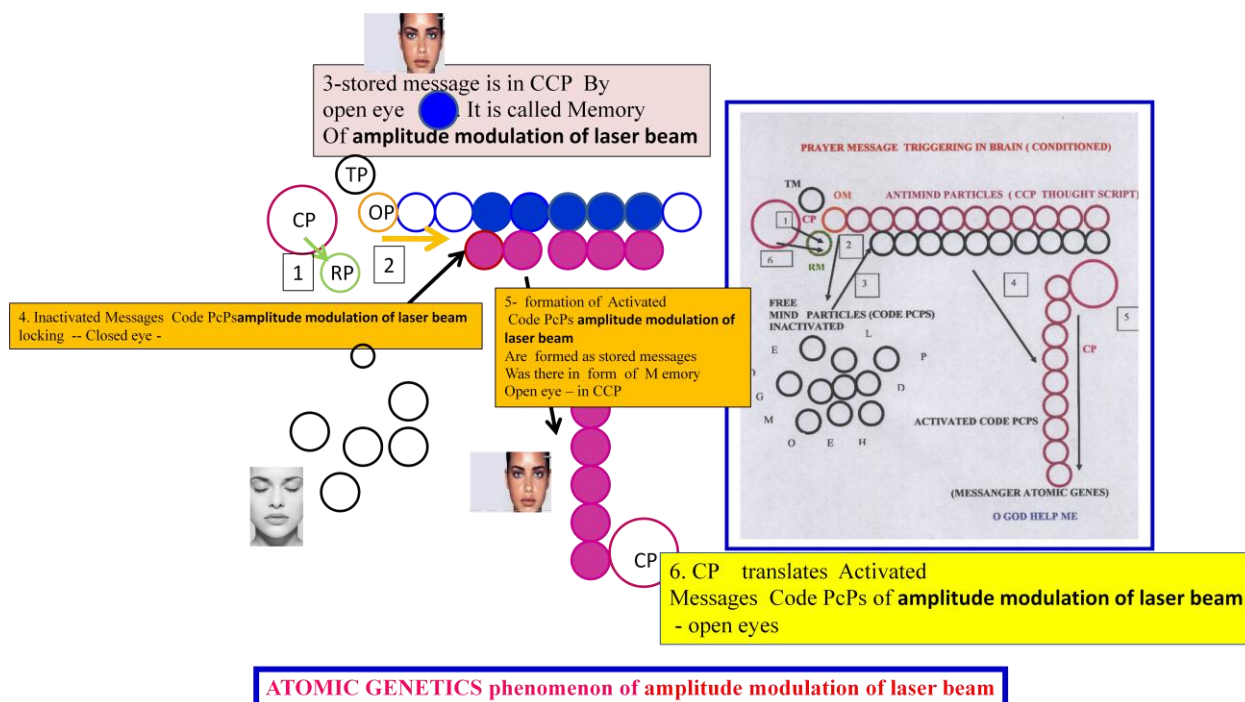
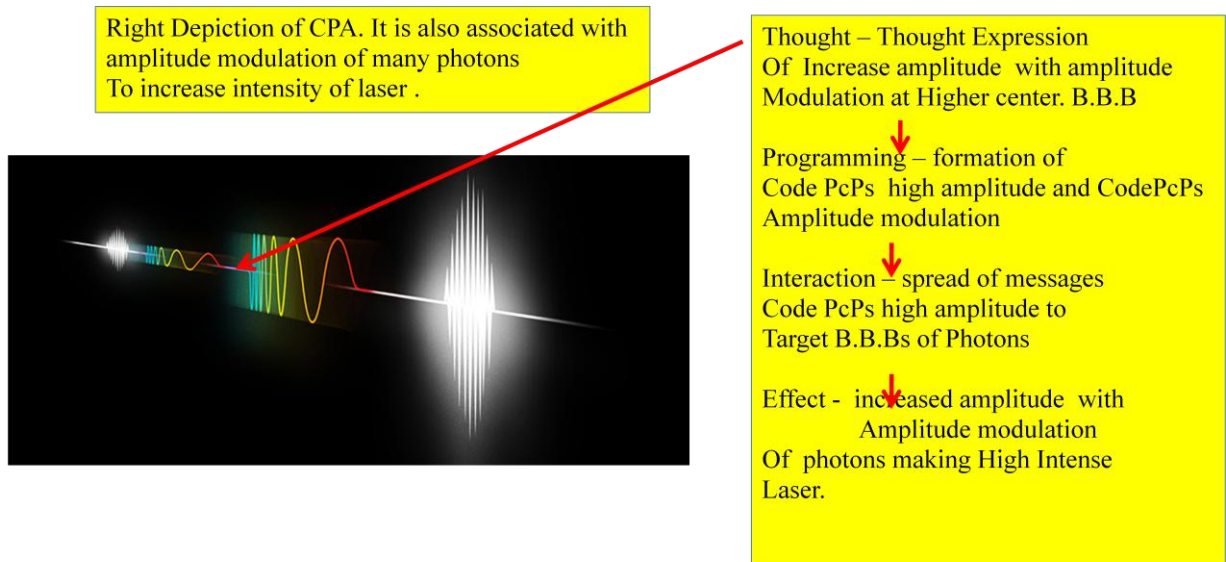

Fig 22 .1- Amplitude Modulation of Laser Beam (micro level)

In phenomenon of **amplitude modulation of laser beam**, following steps take place on Yin B.B.B – B-Bit (Figure 22.1) .

1. CP removes RM (repressor mindness-green) from OM (operating mindness -orange) thus induction of recall is triggered
2. OM searches learning mindness on Anti mind particles (Anti mind particles script) of that thought script (blue filed circles- open eye) of “**amplitude modulation of laser beam**”.
3. But as that learning mindness is there with opening eyes of learnt anti mind particles .
4. Inactivated code PcPs “**amplitude modulation of laser beam**“ mind particles triggering to lock on Anti mind particles script
5. Formation of activated code PcPs “**amplitude modulation of laser beam**” as stored messages was there in form of memory (open eye)
6. Finally there is activated message of “**amplitude modulation of laser beam**” is formed (Filled magenta circle – open eyes) by CCP (filled circle blue –open eyes) . CP makes phenomenon of splicing .
7. CP represses act of recall memory by adding RM (green) to OM (orange) . Thus recalling information s of “**amplitude modulation of laser beam**” gets halt.

It is the mind that underpins amplification of Laser Photons with amplitude modulation of many photons making high intense laser beam .



Strickland and Mourou's newly invented technique, called *chirped pulse amplification*, CPA, soon became standard for subsequent high-intensity lasers.

Fig 23 Right Depiction of CPA . It is also associated with amplitude modulation of many photons To increase intensity of laser . (macro level)

2.4 Atomic genetics and basic etiology of cancer

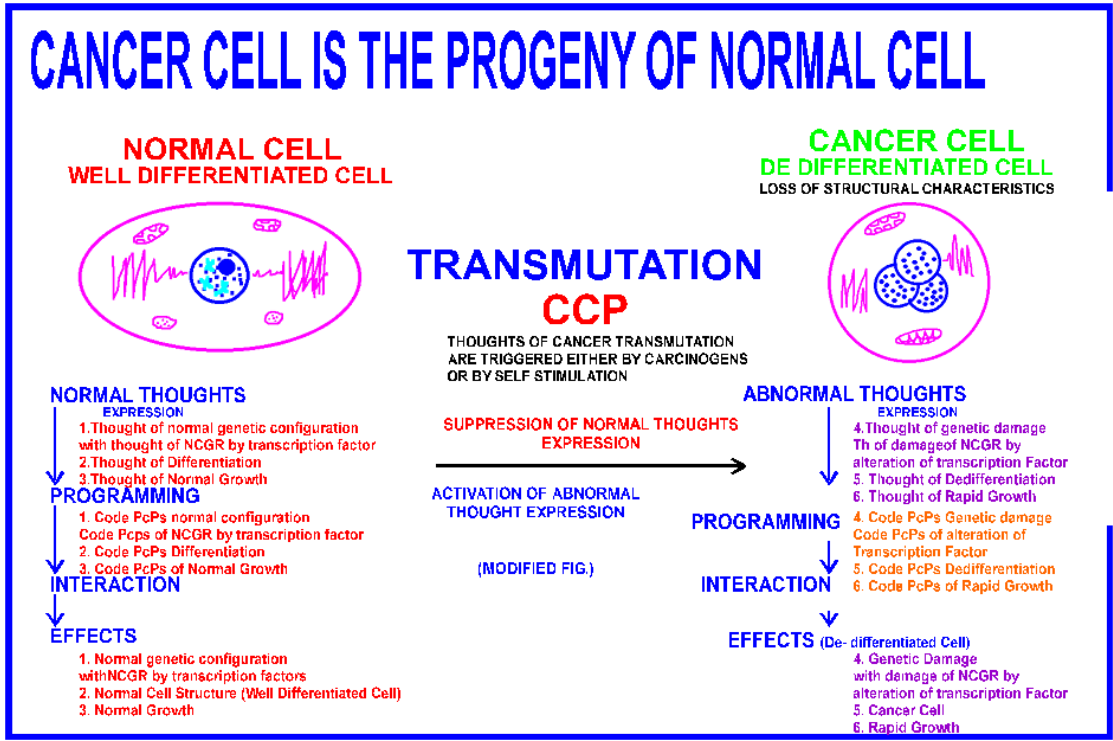

Fig 24 Basic Etiology of cancer . It is transmutation of cell rather than evolutionary molecular Biology

Cancer is supposed to a multi step phenomenon and the basic etiology does not lie in genetic damage or molecular basis. Cancer is multi step phenomenon but transmutation occurring in each step is triggered by carcinogens by sending the messages of shifting to each higher center (**BASIC BUILDING BLOCKS**) involved in multi step. The basic etiology is not molecular genetics damage rather shifting of thought expressions from normal to abnormal thought expressions at the level of **BASIC BUILDING BLOCKS** that constitute that **molecule**. With the result the molecules show changes in structures functions and laws.

Phenomenon of transmutation means change in shape, properties and laws. All three are triggered by separate thought expressions. In carcinogenesis all three thoughts are transmutating. It could be chromosomal structural changes, It could be cellular structural changes or it could be biochemical changes, It could be staining changes, It could be any other, which is not present in normal cell structure and functions. So the basic cause in all these changes is shifting of normal atomic transcription to abnormal atomic transcription and that is triggered by carcinogens. Carcinogenesis is supposed to be a multi factorial disease. Yes, it is multi factorial. But what is **COMMON** in all factors. All factors carry programmed thought of shifting from normal thought expressions to abnormal thought expressions. What is common in all cancer transmutation? It is the shifting of thought expressions from normal to abnormal thought expressions and that is triggered by carcinogens or it is self stimulated (hereditary factors).

LAWS OF INDEPENDENT ASSORTMENT STATES THAT IT IS AN ILLUSION THAT GENETIC DAMAGE TRIGGER ACTIVATION OF ONCOGENES AND FURTHER THEY TRIGGER ONCOGENESIS.

It is the basic building blocks (higher centers), which are the basis of molecular alterations, and the fundamental characteristics are shifting of thought expressions from normal to abnormal that is shared by all malignant tumors. The basic principles that govern carcinogenesis, are the laws made by **GREGOR MENDEL** i.e. the laws of **INHERITANCE**. Genetic damage is an effect not the cause of cancer. **THE CAUSE OF CANCER IS SHIFTING OF THOUGHT EXPRESSIONS FROM NORMAL TO ABNORMAL, WHICH IS CAUSED BY EITHER OUTER STIMULI, OR THEY ARE SELF-STIMULATED. Without shifting the thought expressions from normal to abnormal, neither one can have genetic damage,**

LAWS OF INDEPENDENT ASSORTMENT STATES THAT IT IS AN ILLUSION THAT GENETIC DAMAGE TRIGGER ACTIVATION OF ONCOGENES AND FURTHER THEY TRIGGER ONCOGENESIS.

It is the basic building blocks (higher centers), which are the basis of molecular alterations, and the fundamental characteristics are shifting of thought expressions from normal to abnormal that is shared by all malignant tumors.

The basic principles that govern carcinogenesis, are the laws made by **GREGOR MENDEL** i.e. the laws of **INHERITANCE**. Genetic damage is an effect not the cause of cancer. **THE CAUSE OF CANCER IS SHIFTING OF THOUGHT EXPRESSIONS FROM NORMAL TO ABNORMAL, WHICH IS CAUSED BY EITHER OUTER STIMULI, OR THEY ARE SELF-STIMULATED. Without shifting the thought expressions from normal to abnormal, neither one can have genetic damage,**

Having read **Atomic genetics and Basic etiology of the cancer**, now we discuss how atomic genetics trigger molecular effects like genetic damage etc during carcinogenesis. **ATOMIC GENETICS** is a new branch of science in which we study about **Laws, PROPERTIES** and **FUNCTIONS** of atomic genes. Now I shall highlight the laws on which atomic genes work. As we have seen that Gregor Mendel had made three laws of inheritance known as ---

1.The principle of Dominance---- Mendel therefore concluded that what were transmitted from parent to offspring were discrete factors. Each factor contained information about the form of the trait. The factor associated with the form which was expressed in the hybrid offspring (F1) was **DOMINANT**. For example, the factor for yellow seed color was a dominant factor. The factor associated with the form which remained hidden in the **F1** but reappeared in the **F2** was **RECESSIVE**, Thus the factor for the green seed color was recessive. Mendel's factor is now recognized as the gene. In atomic genetics this law is interpreted like this ---- During atomic transcription or thought expressions few thoughts are expressed and these are called dominating thoughts and rest thoughts which are not expressed are called recessive thoughts. Thus particles, atoms and molecules show only those properties which are triggered by dominating thought expressions. **During transmutation, dominating thoughts get recessive while recessive thoughts get dominant.** Single effect or property is triggered by single dominating thought expression or atomic transcription. **For example--** Normal genetic arrangements are triggered by normal arrangement genetic dominating thought expressions while genetic damage is triggered by abnormal arrangement genetic dominating thought expressions. Abnormal arrangement genetic thought expression is triggered by carcinogens only after normal arrangement genetic thought expressions get recessive. Or we can say normal genetic arrangement are triggered

by normal arrangement genetic thought expressions and when carcinogens come in contact with the cell, they shift the thought expression from normal to abnormal genetic arrangement. With the result we observe genetic damage. Thus carcinogens suppress dominating normal arrangement genetic thoughts and they trigger abnormal arrangement recessive genetic thoughts. With the result genetic damage is seen.

2.The Principle of Segregation---The principle of segregation states that allele pairs separate or segregate during gamete formation, and the paired condition is restored by random fusion of gametes during fertilization. In atomic genetics it will be interpreted like this --- There is separate atomic transcription for separate effects. So if there are hundred effects, they all are triggered by hundred separate thought expressions or atomic transcriptions.

For example --- Genetic damage is triggered by separate thought expression and rapid growth is triggered by separate thought expression and dedifferentiation is triggered by separate thought expression. And all these thought expressions are triggered by carcinogens. **But the timing of thought expressions is different.** Genetic damage thought expression is first to trigger and later rapid growth and dedifferentiation thought expressions.

3. The Principle of independent assortment--- The principle of independent assortment states that if we consider the inheritance of two or more genes at a time, there distribution in the gametes and in the progeny of subsequent generations is independent of each other. In atomic genetics it will be interpreted like this--- In one phenomenon, if two or more than two transcriptions or thought expressions are expressed that will give rise to two or more than two effects, **it dose not mean that there expression is DEPENDENT ON EACH OTHER.**

For example --- In phenomenon of carcinogenesis, there is effect of genetic damage, there is effect of rapid growth and there is effect of dedifferentiation. All these effects are triggered by separate thought expressions. The simultaneous expression of these atomic transcriptions is independent of each other. Or these thoughts expressions are the part of the carcinogenesis phenomenon but their expressions are independent of one another. **It does mean that for rapid growth thought expression, genetic damage thought expression is NOT essential.**

Having informed about the laws and working of atomic genes, Now we discuss phenomenon of carcinogenesis, which is triggered by, outer stimuli like physical, chemical carcinogens or virus or they are self stimulated i.e. hereditary factors.

**When Genetic damage is not essential for cancer transmutation then what is the role of Genetic damage?
. Why do carcinogens trigger genetic damage first? How do carcinogens trigger carcinogenesis?**

Right Depiction - Divine Mechanics that underpins brakes by CTLA-4 or PD-1 and inhibition of Brakes by Anti CTLA-4 or Anti PD-1 in our immune system (micro level)

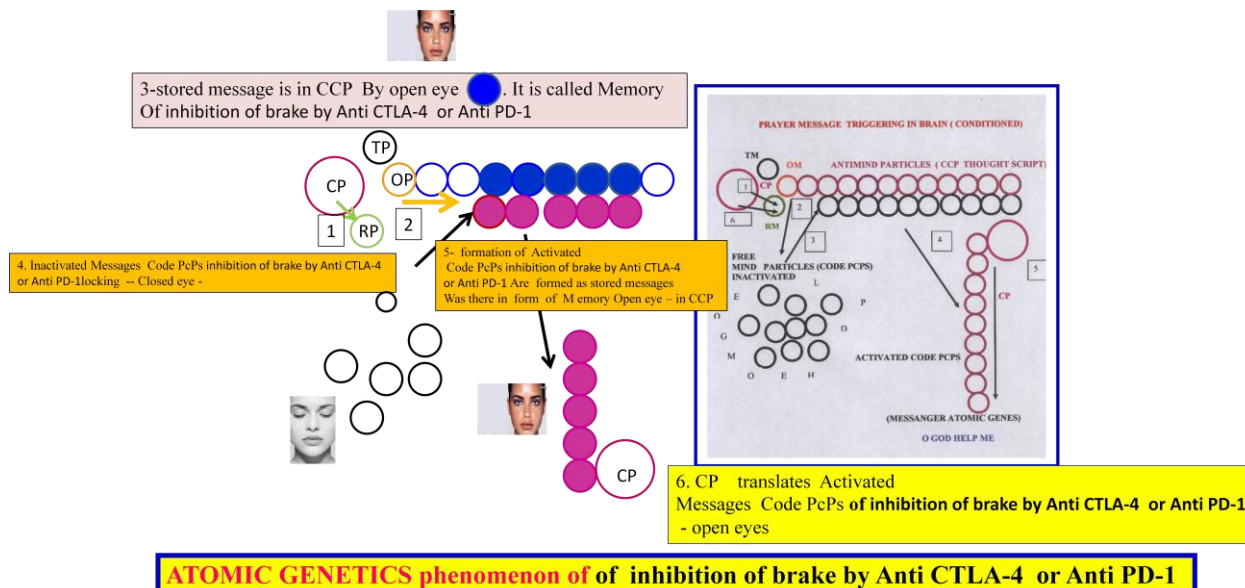

Fig 25 Triggering of thought of inhibition of brake at higher center by Anti CTLA-4 or Anti PD-1 molecules

In phenomenon of inhibition of brake by Anti CTLA-4 or Anti PD-1, following steps take place on Yang B.B.B – B-Bit (Figure 25) .

1. CP removes RM (repressor mindness-green) from OM (operating mindness -orange) thus induction of recall is triggered
2. OM searches learning mindness on Anti mind particles (Anti mind particles script) of that thought script (blue filed circles- open eye) of “inhibition of brake by Anti CTLA-4 or Anti PD-1”.
3. But as that learning mindness is there with opening eyes of learnt anti mind particles .
4. Inactivated code PcPs “inhibition of brake by Anti CTLA-4 or Anti PD-1 “ mind particles triggering to lock on Anti mind particles script
5. Formation of activated code PcPs “inhibition of brake by Anti CTLA-4 or Anti PD-1” as stored messages was there in form of memory (open eye)
6. Finally there is activated message of “ inhibition of brake by Anti CTLA-4 or Anti PD-1” is formed (Filled magenta circle – open eyes) by CCP (filled circle blue –open eyes) . CP makes phenomenon of splicing .
7. CP represses act of recall memory by adding RM (green) to OM (orange) . Thus recalling information s of “inhibition of brake by Anti CTLA-4 or Anti PD-1” gets halt.

Right Depiction - Divine Mechanics that underpins brakes by CTLA-4 or PD-1 and inhibition of Brakes by Anti CTLA-4 or Anti PD-1 in our immune system (macro level)

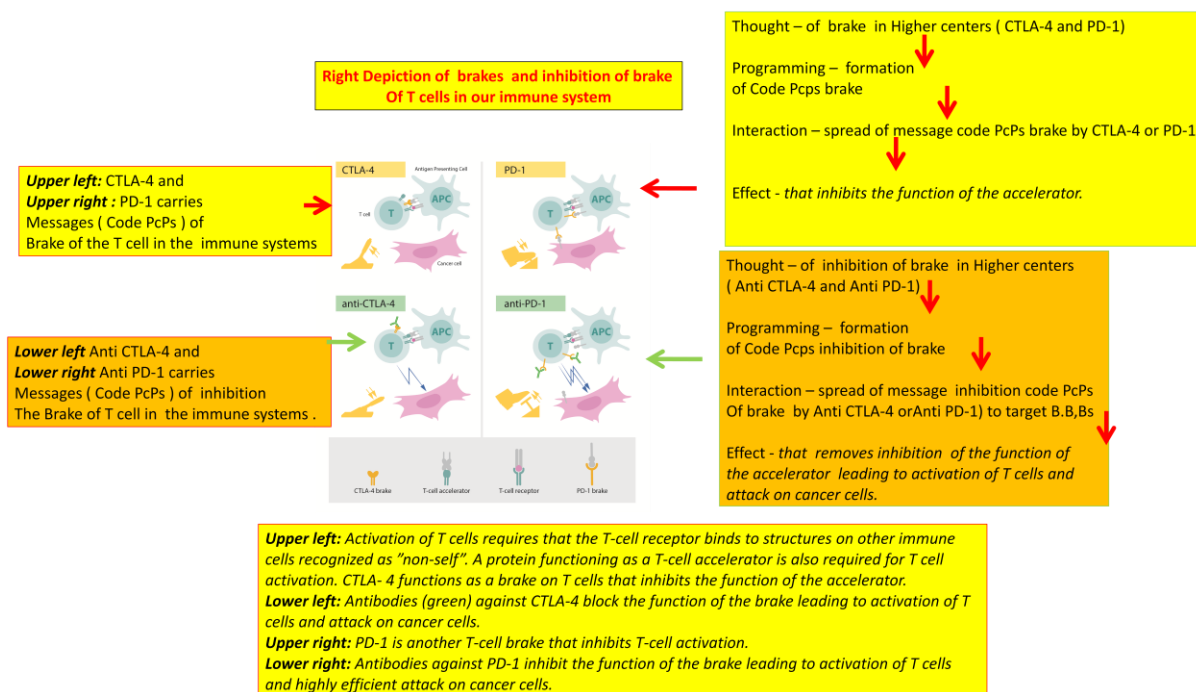

Fig 26 Right Depiction - Divine Mechanics that underpins brakes by CTLA-4 or PD-1 and inhibition of Brakes by Anti CTLA-4 or PD-1 molecules in our immune system (macro level)

IV. Conclusion

It is myth that we evolved from Evolutionary molecular biology . The basic etiology of cancer is shifting of thought expressions from normal to abnormal rather than any evolutionary molecular biology . During origin of Earth and Life , nature took different shapes by virtue of unconditioned thought expressions rather than any physical activity like hitting of comets to Earth that causes shifting of continents . Power of biological evolution is Divine Mechanics that too by unconditioned working about 3.5 billions years back when first blue green algae was formed from soil by unconditioned working of thought . It is the transmutation phenomenon that is the basis what we call evolutionary molecular biology . Transmutation is found in particles , atoms , molecules , bio molecular , cells (cancer formation) , organ , systems , individuals . These are fed thoughts and feeding was done in pre creation era by Highest center of the universe . To understand brake and inhibition of brake of T cell in our immune system , we have to understand pharmacogenetics where CTLA-4 or PD-1 or their Anti CTLA-4 or Anti PD-1 , after tie up with receptors of cell send messages (Code PcPs) to target B.B.Bs to trigger effects (brake or inhibition of brake of T cell) as sent by higher center to them through bio molecules (CTLA-4 , PD-1 or Anti CTLA-4 , Anti PD-1) . There are many thoughts to trigger the effects . There is feedback mechanism to higher center before next thought is triggered . Triggering and regulation is controlled by Time mindness (TM) . Similarly photons behavior changes with change of amplitude and amplitude modulation leading to formation of intense laser . There are many thoughts to trigger the effects . There is feedback mechanism to higher center before next thought is triggered . Triggering and regulation is controlled by Time mindness (TM) . It is divine mechanics (CCP , CodePcPs and CP) that underpins all sciences . It is theory of Everything (ToE) . Hence Noble prize Chemistry , Physics and Physiology (2018) are on incomplete theory work .

References

- [1]. <https://www.kva.se/en/pressrum/pressmeddelanden/nobelpriset-i-kemi-2018>
<https://www.kva.se/en/pressrum/pressmeddelanden/nobelpriset-i-fysik-2018>
<https://www.nobelprize.org/prizes/medicine/2018/press-release/>
- [2]. V M Das *International journal of innovative research and development* **Volume 3 Issue 8** p 194- 210 (2014)
- [3]. V M Das *International Journal of Sciences: Basic and Applied Research (IJSBAR)* **Volume 17, No 1**, p 292-324 (2014)
- [4]. V M Das *International Journal of Sciences: Basic and Applied Research*, **Volume 17, No 1**, p 148-185 (2014)

- [5]. V M Das *International Journal of Sciences: Basic and Applied Research* **Volume 16, No 2**, p 274-309 (2014)
- [6]. W S Harris *JAMA Arch Intern Med.* **Volume 159, N019** , Oct-25 p 2273-2278 (1999)
- [7]. V M Das *International Journal of Sciences: Basic and Applied Research* **volume 16 , number 1** , p 311-338 (2014)
- [8]. V M Das *Social and basic sciences and research review* **Volume 2**, Issue 4 p 197-255 (2014)
- [9]. V.M.Das *Asian Journal of Science and Technology* **Vol.06 Issue 12**, pp.2075-2099 (2015)
- [10]. V.M.Das *INTERNATIONAL JOURNAL OF SCIENTIFIC RESEARCH* **Volume 4 Issue 5** pp 795-804 (2015)
- [11]. <https://www.youtube.com/watch?v=Fb3gn5GsvRk>

V M Das . “Noble Prize Chemistry , Noble Prize Physics and Noble Prize Physiology (2018) Are On Incomplete Theory Work . Unless Divine Mechanics (CCP , Code PcPs and CP) Or ToE , That Underpins All Sciences , Is Explained First , Work Should Not Be Honored .(Marks Allotted 3 out of 10 to Each Noble Prize)” *IOSR Journal of Research & Method in Education (IOSR-JRME)* , vol. 8, no. 5, 2018, pp. 69-102.